

Nikon

DIGITAL CAMERA

D3200

Reference Manual

En

Thank you for your purchase of a Nikon single-lens reflex (SLR) digital camera. To get the most from your camera, please be sure to read all instructions thoroughly and keep them where they will be read by all who use the product.

Symbols and Conventions

To make it easier to find the information you need, the following symbols and conventions are used:



This icon marks cautions; information that should be read before use to prevent damage to the camera.



This icon marks notes; information that should be read before using the camera.



This icon marks references to other pages in this manual.

Menu items, options, and messages displayed in the camera monitor are shown in **bold**.

Camera Settings

The explanations in this manual assume that default settings are used.

Help

Use the camera's on-board help feature for help on menu items and other topics. See page 9 for details.

Digitutor

"Digitutor", a series of "watch and learn" manuals in movie form, is available from the following website: http://www.nikondigitutor.com/index_eng.html

















For Your Safety

Before using the camera for the first time, read the safety instructions in "For Your Safety" (ix–xiv).

Where to Find It

Find what you're looking for from:

-  **The Table of Contents**  **iv**  **Error Messages**.....  **193**
-  **The Q&A Index**.....  **ii**  **Troubleshooting**  **189**
-  **The Index**  **210**

 Introduction	 1
 Basic Photography	 21
 Guide Mode	 27
 More on Photography (All Modes)	 31
 P, S, A, and M Modes	 53
 Live View	 80
 Recording and Viewing Movies	 88
 Playback and Deletion	 97
 Connections	 111
 The Playback Menu	 125
 The Shooting Menu	 127
 The Setup Menu	 133
 The Retouch Menu	 149
 Recent Settings	 166
 Technical Notes	 167

Q&A Index

Find what you're looking for using this "question and answer" index.



Taking Photographs



Shooting Modes and Framing Options

Is there a quick and easy way to take snapshots?	22–24
How do I use the GUIDE position on the mode dial?	27–30
How do I quickly adjust settings for different scenes?	25–26
Can I adjust shutter speed to freeze or blur motion (mode S)?	55
Can I adjust aperture to blur backgrounds or bring them into focus (mode A)?	56
How do I make long ("time") exposures (mode M)?	58
Can I frame photos in the monitor (live view)?	80–87
Can I shoot movies?	88–89



Release Modes

Can I take photos one at a time or in quick succession?	31
How do I take pictures with the self-timer or a remote control?	33
Can I reduce shutter noise in quiet surroundings? (quiet shutter release)	31



Focus

Can I choose how the camera focuses?	35–36
Can I choose the focus point?	40



Image Quality and Size

How do I take pictures for printing at large sizes?	44–46
How can I get more pictures on the memory card?	



Exposure

Can I make photos brighter or darker?	63
How do I preserve details in shadows and highlights?	67–68



Using the Flash

Can I set the flash to fire automatically when needed?	
How do I keep the flash from firing?	47–50
How do I avoid "red-eye"?	



Viewing Photographs



Playback

How do I view photographs on the camera?	97
How do I view more information about a photo?	98–101
Can I view photos in an automatic slide show?	109
Can I view photos on a TV?	122–124
Can I protect photos from accidental deletion?	105



Deletion

How do I delete unwanted photos?	106–108
----------------------------------	---------



Retouching Photographs



How do I create retouched copies of photos?	149–165
How do I remove “red-eye”?	151
How do I make JPEG copies of RAW (NEF) photos?	157
Can I overlay two NEF (RAW) photos to make a single image?	155–156
Can I create a copy of a photo that looks like a painting?	160
Can I trim movie footage on the camera or save movie stills?	93–96



Menus and Settings



How do I adjust settings in the information display?	5–6
How do I use the menus?	9–11
How do I display menus in another language?	16, 137
How do I keep the displays from turning off?	140
How do I focus the viewfinder?	20
Can I display a framing grid in the monitor?	85
How do I set the camera clock?	16, 137
How do I format memory cards?	19
How do I restore default settings?	128, 134
Is there any way to stop the camera beeping?	141
How do I get help for a menu or message?	9, 193



Connections



How do I copy photos to a computer?	111–113
How do I print photos?	114–121
Can I print the date of recording on my photos?	116, 121, 144



Maintenance and Optional Accessories



What memory cards can I use?	177
What lenses can I use?	167
What optional flash units (Speedlights) can I use?	172
What other accessories are available for my camera?	176
What software is available for my camera?	176
What do I do with the supplied eyepiece cap?	34
How do I clean the camera?	179
Where should I take my camera for servicing and repairs?	179

Table of Contents

Q&A Index	ii
For Your Safety	ix
Notices.....	xi
Introduction	1
Getting to Know the Camera.....	1
The Camera Body	1
The Mode Dial.....	3
The Viewfinder.....	4
The Information Display.....	5
The Command Dial	7
Camera Menus.....	9
Using Camera Menus	10
First Steps	12
Charge the Battery	12
Insert the Battery	13
Attach a Lens.....	14
Basic Setup.....	16
Insert a Memory Card.....	18
Format the Memory Card	19
Adjust Viewfinder Focus	20
Basic Photography	21
Battery Level and Card Capacity	21
“Point-and-Shoot” Photography (AUTO and Modes).....	22
Creative Photography (Scene Modes)	25
Portrait	25
Landscape.....	25
Child	25
Sports	26
Close up.....	26
Night Portrait.....	26
Guide Mode	27
The Guide	27
Guide Mode Menus	28
Using the Guide	30

More on Photography (All Modes) 31

Release Mode	31
Self-Timer and Remote Control Modes	33
Focus	35
Focus Mode	35
AF-Area Mode	38
Focus Point Selection	40
Focus Lock	40
Manual Focus	42
Image Quality and Size	44
Image Quality	44
Image Size	46
Using the Built-in Flash	47
Flash Mode	48
ISO Sensitivity	51

P, S, A, and M Modes 53

Shutter Speed and Aperture	53
Mode P (Programmed Auto)	54
Mode S (Shutter-Priority Auto)	55
Mode A (Aperture-Priority Auto)	56
Mode M (Manual)	57
Exposure	60
Metering	60
Autoexposure Lock	61
Exposure Compensation	63
Flash Compensation	65
Preserving Detail in Highlights and Shadows	67
Active D-Lighting	67
White Balance	69
Fine-Tuning White Balance	71
Preset Manual	72
Picture Controls	76
Selecting a Picture Control	76
Modifying Picture Controls	77

Live View 80

Framing Photographs in the Monitor	80
Focusing in Live View	81

Recording and Viewing Movies **88**

Recording Movies.....	88
Movie Settings.....	90
Viewing Movies.....	92
Editing Movies.....	93
Trimming Movies.....	93
Saving Selected Frames.....	96

Playback and Deletion **97**

Full-Frame Playback.....	97
Photo Information.....	98
Thumbnail Playback.....	102
Calendar Playback.....	103
Taking a Closer Look: Playback Zoom.....	104
Protecting Photographs from Deletion.....	105
Deleting Photographs.....	106
Full-Frame, Thumbnail, and Calendar Playback.....	106
The Playback Menu.....	107
Slide Shows.....	109

Connections **111**

Connecting to a Computer.....	111
Before Connecting the Camera.....	111
Connecting the Camera.....	112
Printing Photographs.....	114
Connecting the Printer.....	114
Printing Pictures One at a Time.....	115
Printing Multiple Pictures.....	117
Creating a DPOF Print Order: Print Set.....	120
Viewing Photographs on TV.....	122
Standard Definition Devices.....	122
High-Definition Devices.....	123

Menu Guide **125**

▶ The Playback Menu: <i>Managing Images</i>	125
Playback Folder.....	125
Playback Display Options.....	126
Image Review.....	126
Rotate Tall.....	126

📷 The Shooting Menu: <i>Shooting Options</i>	127
Reset Shooting Menu	128
ISO Sensitivity Settings.....	129
Auto Distortion Control	130
Color Space.....	130
Noise Reduction.....	131
Built-in AF-assist Illuminator	131
Flash Cntrl for Built-in Flash.....	132
🔧 The Setup Menu: <i>Camera Setup</i>	133
Reset Setup Options.....	134
Monitor Brightness	134
Info Display Format	134
Auto Info Display	136
Video Mode	136
Flicker Reduction.....	136
Time Zone and Date.....	137
Language	137
Image Comment.....	138
Auto Image Rotation.....	138
Image Dust Off Ref Photo.....	139
Auto off Timers.....	140
Self-Timer	141
Remote on Duration.....	141
Beep	141
Rangefinder.....	142
File Number Sequence	142
Buttons.....	143
Slot Empty Release Lock	144
Print Date	144
Storage Folder	146
GPS.....	147
Eye-Fi Upload.....	148
Firmware Version.....	148
🔪 The Retouch Menu: <i>Creating Retouched Copies</i>	149
Creating Retouched Copies	150
D-Lighting.....	151
Red-Eye Correction	151
Trim	152
Monochrome	152
Filter Effects.....	153
Color Balance.....	154
Image Overlay.....	155
NEF (RAW) Processing.....	157
Resize	158

Quick Retouch.....	159
Straighten	159
Distortion Control	159
Fisheye	160
Color Outline	160
Color Sketch.....	160
Perspective Control.....	161
Miniature Effect	162
Selective Color	163
Side-by-side Comparison.....	165
 Recent Settings	166

Technical Notes 167

Compatible Lenses.....	167
Compatible CPU Lenses	167
Compatible Non-CPU Lenses	169
Optional Flash Units (Speedlights).....	172
The Nikon Creative Lighting System (CLS).....	173
Other Accessories	176
Approved Memory Cards	177
Attaching a Power Connector and AC Adapter.....	178
Caring for the Camera.....	179
Storage	179
Cleaning.....	179
The Low-Pass Filter	180
Caring for the Camera and Battery: Cautions.....	184
Caring for the Camera.....	184
Caring for the Battery.....	185
Available Settings.....	187
Memory Card Capacity	188
Troubleshooting	189
Display	189
Shooting (All Modes).....	189
Shooting (P, S, A, M)	191
Playback.....	191
Miscellaneous	192
Error Messages.....	193
Specifications	196
Lenses	203
Battery Life	209
Index.....	210











For Your Safety

To prevent damage to your Nikon product or injury to yourself or to others, read the following safety precautions in their entirety before using this equipment. Keep these safety instructions where all those who use the product will read them.

The consequences that could result from failure to observe the precautions listed in this section are indicated by the following symbol:

 This icon marks warnings. To prevent possible injury, read all warnings before using this Nikon product.

■ ■ WARNINGS

-  **Keep the sun out of the frame**
Keep the sun well out of the frame when shooting backlit subjects. Sunlight focused into the camera when the sun is in or close to the frame could cause a fire.
-  **Do not look at the sun through the viewfinder**
Viewing the sun or other strong light source through the viewfinder could cause permanent visual impairment.
-  **Using the viewfinder diopter adjustment control**
When operating the viewfinder diopter adjustment control with your eye to the viewfinder, care should be taken not to put your finger in your eye accidentally.
-  **Turn off immediately in the event of malfunction**
Should you notice smoke or an unusual smell coming from the equipment or AC adapter (available separately), unplug the AC adapter and remove the battery immediately, taking care to avoid burns. Continued operation could result in injury. After removing the battery, take the equipment to a Nikon-authorized service center for inspection.
-  **Do not use in the presence of flammable gas**
Do not use electronic equipment in the presence of flammable gas, as this could result in explosion or fire.
-  **Keep out of reach of children**
Failure to observe this precaution could result in injury. In addition, note that small parts constitute a choking hazard. Should a child swallow any part of this equipment, consult a physician immediately.
-  **Do not disassemble**
Touching the product's internal parts could result in injury. In the event of malfunction, the product should be repaired only by a qualified technician. Should the product break open as the result of a fall or other accident, remove the battery and/or AC adapter and then take the product to a Nikon-authorized service center for inspection.
-  **Do not place the strap around the neck of an infant or child**
Placing the camera strap around the neck of an infant or child could result in strangulation.
-  **Do not remain in contact with the camera, battery, or charger for extended periods while the devices are on or in use**
Parts of the device become hot. Leaving the device in direct contact with the skin for extended periods may result in low-temperature burns.
-  **Do not aim a flash at the operator of a motor vehicle**
Failure to observe this precaution could result in accidents.

- ⚠ Observe caution when using the flash**
- Using the camera with the flash in close contact with the skin or other objects could cause burns.
 - Using the flash close to the subject's eyes could cause temporary visual impairment. Particular care should be observed when photographing infants, when the flash should be no less than one meter (39 in.) from the subject.

- ⚠ Avoid contact with liquid crystal**
- Should the monitor break, care should be taken to avoid injury due to broken glass and to prevent the liquid crystal from the monitor touching the skin or entering the eyes or mouth.

- ⚠ Observe proper precautions when handling batteries**
- Batteries may leak or explode if improperly handled. Observe the following precautions when handling batteries for use in this product:
- Use only batteries approved for use in this equipment.
 - Do not short or disassemble the battery.
 - Be sure the product is off before replacing the battery. If you are using an AC adapter, be sure it is unplugged.
 - Do not attempt to insert the battery upside down or backwards.
 - Do not expose the battery to flame or to excessive heat.
 - Do not immerse in or expose to water.
 - Replace the terminal cover when transporting the battery. Do not transport or store the battery with metal objects such as necklaces or hairpins.
 - Batteries are prone to leakage when fully discharged. To avoid damage to the product, be sure to remove the battery when no charge remains.
 - When the battery is not in use, attach the terminal cover and store in a cool, dry place.

- The battery may be hot immediately after use or when the product has been used on battery power for an extended period. Before removing the battery turn the camera off and allow the battery to cool.
- Discontinue use immediately should you notice any changes in the battery, such as discoloration or deformation.

⚠ Observe proper precautions when handling the charger

- Keep dry. Failure to observe this precaution could result in fire or electric shock.
- Do not short the charger terminals. Failure to observe this precaution could result in overheating and damage to the charger.
- Dust on or near the metal parts of the plug should be removed with a dry cloth. Continued use could result in fire.
- Do not go near the charger during thunderstorms. Failure to observe this precaution could result in electric shock.
- Do not handle the plug or charger with wet hands. Failure to observe this precaution could result in electric shock.
- Do not use with travel converters or adapters designed to convert from one voltage to another or with DC-to-AC inverters. Failure to observe this precaution could damage the product or cause overheating or fire.

- ⚠ Use appropriate cables**
- When connecting cables to the input and output jacks, use only the cables provided or sold by Nikon for the purpose to maintain compliance with product regulations.

- ⚠ CD-ROMs**
- CD-ROMs containing software or manuals should not be played back on audio CD equipment. Playing CD-ROMs on an audio CD player could cause hearing loss or damage the equipment.

Notices

- No part of the manuals included with this product may be reproduced, transmitted, transcribed, stored in a retrieval system, or translated into any language in any form, by any means, without Nikon's prior written permission.
- Nikon reserves the right to change the specifications of the hardware and software described in these manuals at any time and without prior notice.
- Nikon will not be held liable for any damages resulting from the use of this product.
- While every effort has been made to ensure that the information in these manuals is accurate and complete, we would appreciate it were you to bring any errors or omissions to the attention of the Nikon representative in your area (address provided separately).

Notice for Customers in Canada

CAN ICES-3 B / NMB-3 B

Notices for Customers in Europe

CAUTION
RISK OF EXPLOSION IF BATTERY IS REPLACED BY AN INCORRECT TYPE. DISPOSE OF USED BATTERIES ACCORDING TO THE INSTRUCTIONS.

This symbol indicates that electrical and electronic equipment is to be collected separately.



The following apply only to users in European countries:

- This product is designated for separate collection at an appropriate collection point. Do not dispose of as household waste.
- Separate collection and recycling helps conserve natural resources and prevent negative consequences for human health and the environment that might result from incorrect disposal.
- For more information, contact the retailer or the local authorities in charge of waste management.

This symbol on the battery indicates that the battery is to be collected separately.



The following apply only to users in European countries:

- All batteries, whether marked with this symbol or not, are designated for separate collection at an appropriate collection point. Do not dispose of as household waste.
- For more information, contact the retailer or the local authorities in charge of waste management.

Notices for Customers in the U.S.A.

The Battery Charger

**IMPORTANT SAFETY INSTRUCTIONS—SAVE THESE INSTRUCTIONS
DANGER—TO REDUCE THE RISK OF FIRE OR ELECTRIC SHOCK, CAREFULLY
FOLLOW THESE INSTRUCTIONS**

For connection to a supply not in the U.S.A., use an attachment plug adapter of the proper configuration for the power outlet if needed. This power unit is intended to be correctly oriented in a vertical or floor mount position.

Federal Communications Commission (FCC) Radio Frequency Interference Statement

This equipment has been tested and found to comply with the limits for a Class B digital device, pursuant to Part 15 of the FCC rules. These limits are designed to provide reasonable protection against harmful interference in a residential installation. This equipment generates, uses, and can radiate radio frequency energy and, if not installed and used in accordance with the instructions, may cause harmful interference to radio communications. However, there is no guarantee that interference will not occur in a particular installation. If this equipment does cause harmful interference to radio or television reception, which can be determined by turning the equipment off and on, the user is encouraged to try to correct the interference by one or more of the following measures:

- Reorient or relocate the receiving antenna.
- Increase the separation between the equipment and receiver.
- Connect the equipment into an outlet on a circuit different from that to which the receiver is connected.
- Consult the dealer or an experienced radio/television technician for help.



CAUTIONS

Modifications

The FCC requires the user be notified that any changes or modifications made to this device that are not expressly approved by Nikon Corporation may void the user's authority to operate the equipment.

Interface Cables

Use the interface cables sold or provided by Nikon for your equipment. Using other interface cables may exceed the limits of Class B Part 15 of the FCC rules.

Notice for Customers in the State of California

WARNING: Handling the cord on this product may expose you to lead, a chemical known to the State of California to cause birth defects or other reproductive harm. *Wash hands after handling.*

Nikon Inc., 1300 Walt Whitman Road, Melville, New York 11747-3064, U.S.A.
Tel.: 631-547-4200

Notice Concerning Prohibition of Copying or Reproduction

Note that simply being in possession of material that has been digitally copied or reproduced by means of a scanner, digital camera, or other device may be punishable by law.

• Items prohibited by law from being copied or reproduced

Do not copy or reproduce paper money, coins, securities, government bonds, or local government bonds, even if such copies or reproductions are stamped "Sample."

The copying or reproduction of paper money, coins, or securities which are circulated in a foreign country is prohibited.

Unless the prior permission of the government has been obtained, the copying or reproduction of unused postage stamps or post cards issued by the government is prohibited.

The copying or reproduction of stamps issued by the government and of certified documents stipulated by law is prohibited.

• Cautions on certain copies and reproductions

The government has issued cautions on copies or reproductions of securities issued by private companies (shares, bills, checks, gift certificates, etc.), commuter passes, or coupon tickets, except when a minimum of necessary copies are to be provided for business use by a company. Also, do not copy or reproduce passports issued by the government, licenses issued by public agencies and private groups, ID cards, and tickets, such as passes and meal coupons.

• Comply with copyright notices

The copying or reproduction of copyrighted creative works such as books, music, paintings, woodcuts, prints, maps, drawings, movies, and photographs is governed by national and international copyright laws. Do not use this product for the purpose of making illegal copies or to infringe copyright laws.

Disposing of Data Storage Devices

Please note that deleting images or formatting memory cards or other data storage devices does not completely erase the original image data. Deleted files can sometimes be recovered from discarded storage devices using commercially available software, potentially resulting in the malicious use of personal image data. Ensuring the privacy of such data is the user's responsibility.

Before discarding a data storage device or transferring ownership to another person, erase all data using commercial deletion software, or format the device and then completely refill it with images containing no private information (for example, pictures of empty sky). Be sure to also replace any pictures selected for preset manual (☐ 72). Care should be taken to avoid injury when physically destroying data storage devices.

AVC Patent Portfolio License

THIS PRODUCT IS LICENSED UNDER THE AVC PATENT PORTFOLIO LICENSE FOR THE PERSONAL AND NON-COMMERCIAL USE OF A CONSUMER TO (i) ENCODE VIDEO IN COMPLIANCE WITH THE AVC STANDARD ("AVC VIDEO") AND/OR (ii) DECODE AVC VIDEO THAT WAS ENCODED BY A CONSUMER ENGAGED IN A PERSONAL AND NON-COMMERCIAL ACTIVITY AND/OR WAS OBTAINED FROM A VIDEO PROVIDER LICENSED TO PROVIDE AVC VIDEO. NO LICENSE IS GRANTED OR SHALL BE IMPLIED FOR ANY OTHER USE. ADDITIONAL INFORMATION MAY BE OBTAINED FROM MPEG LA, L.L.C. SEE <http://www.mpegla.com>

Use Only Nikon Brand Electronic Accessories

Nikon cameras are designed to the highest standards and include complex electronic circuitry. Only Nikon brand electronic accessories (including chargers, batteries, AC adapters, and flash accessories) certified by Nikon specifically for use with this Nikon digital camera are engineered and proven to operate within the operational and safety requirements of this electronic circuitry.

The use of non-Nikon electronic accessories could damage the camera and may void your Nikon warranty. The use of third-party rechargeable Li-ion batteries not bearing the Nikon holographic seal shown at right could interfere with normal operation of the camera or result in the batteries overheating, igniting, rupturing, or leaking.



For more information about Nikon brand accessories, contact a local authorized Nikon dealer.

Use Only Nikon Brand Accessories

Only Nikon brand accessories certified by Nikon specifically for use with your Nikon digital camera are engineered and proven to operate within its operational and safety requirements. THE USE OF NON-NIKON ACCESSORIES COULD DAMAGE YOUR CAMERA AND MAY VOID YOUR NIKON WARRANTY.

Servicing the Camera and Accessories

The camera is a precision device and requires regular servicing. Nikon recommends that the camera be inspected by the original retailer or a Nikon-authorized service representative once every one to two years, and that it be serviced once every three to five years (note that fees apply to these services). Frequent inspection and servicing are particularly recommended if the camera is used professionally. Any accessories regularly used with the camera, such as lenses or optional flash units, should be included when the camera is inspected or serviced.

Before Taking Important Pictures

Before taking pictures on important occasions (such as at weddings or before taking the camera on a trip), take a test shot to ensure that the camera is functioning normally. Nikon will not be held liable for damages or lost profits that may result from product malfunction.

Life-Long Learning

As part of Nikon's "Life-Long Learning" commitment to ongoing product support and education, continually-updated information is available on-line at the following sites:

- **For users in the U.S.A.:** <http://www.nikonusa.com/>
- **For users in Europe and Africa:** <http://www.europe-nikon.com/support/>
- **For users in Asia, Oceania, and the Middle East:** <http://www.nikon-asia.com/>

Visit these sites to keep up-to-date with the latest product information, tips, answers to frequently-asked questions (FAQs), and general advice on digital imaging and photography. Additional information may be available from the Nikon representative in your area. See the following URL for contact information: <http://imaging.nikon.com/>



Introduction

Getting to Know the Camera

Take a few moments to familiarize yourself with camera controls and displays. You may find it helpful to bookmark this section and refer to it as you read through the rest of the manual.

The Camera Body

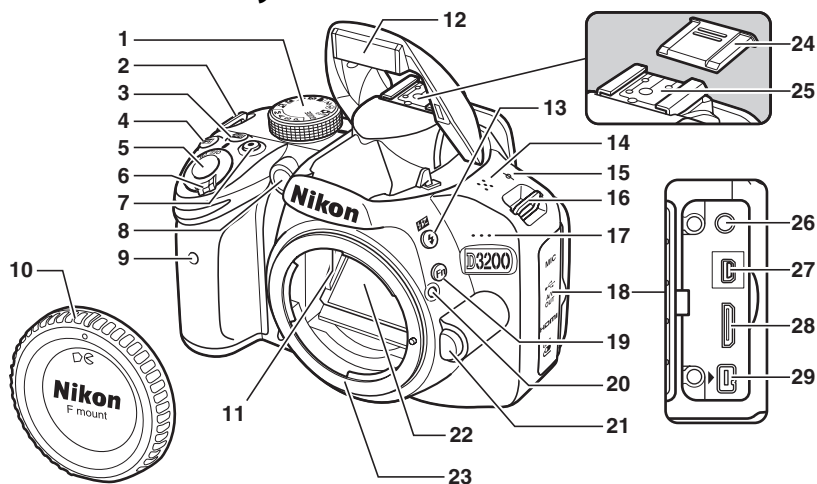

1 Mode dial.....3	12 Built-in flash 47	25 Accessory shoe (for optional flash units)172
2 Eyelet for camera strap	13 button Flash mode 47	26 Connector for external microphone 91, 177
3 (information) button.... 6, 85	Flash compensation 66	27 USB and A/V connector Connecting to a computer112
4 button Exposure compensation...64	14 Speaker.....92	Connecting to a printer114
Adjusting aperture57	15 Focal plane mark (∞) 43	Connecting to a TV122
Flash compensation.....66	16 Eyelet for camera strap	28 HDMI mini-pin connector123
5 Shutter-release button.....24	17 Microphone 88	29 Accessory terminal..... 177
6 Power switch.....2	18 Connector cover	
7 Movie-record button88	19 Fn button Using the Fn button...8, 143	
8 AF-assist illuminator37	20 Mounting mark..... 14	
Self-timer lamp33	21 Lens release button 15	
Red-eye reduction lamp49	22 Mirror182	
9 Infrared receiver (front).....33	23 Lens mount.....43	
10 Body cap	24 Accessory shoe cover 172	
11 CPU contacts		

The Camera Body (Continued)

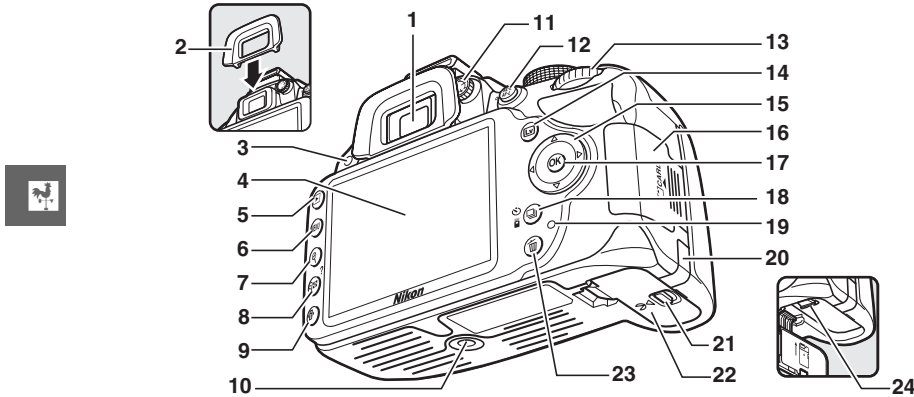

1 Viewfinder eyepiece..... 34	10 Tripod socket	19 Memory card access lamp 18, 23
2 Rubber eyecup	11 Diopter adjustment control 20	20 Power connector cover for optional power connector 178
3 Infrared receiver (rear) 33	12 button Using the (ON) button 41, 143	21 Battery-chamber cover latch 13
4 Monitor Viewing settings..... 5 Live view 80 Full-frame playback..... 97	Protecting photographs from deletion 105	22 Battery-chamber cover 13
5 button Playback 97	13 Command dial 7	23 button Deleting pictures during playback 106
6 MENU button Menu 9, 125	14 button Live view 80 Movie 88	24 Battery latch 13
7 button Playback zoom in 104	15 Multi selector 10	
8 button Thumbnails 102 Playback zoom out 104 Help 9	16 Memory card slot cover 18	
9 (information edit) button 5	17 (OK) button 10	
	18 button Release mode 31 Self-timer 33 Remote control 33	

The Power Switch

Rotate the power switch as shown to turn the camera on.

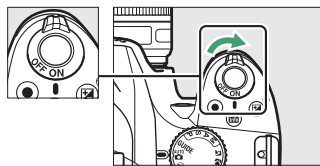

Rotate the power switch as shown to turn the camera off.

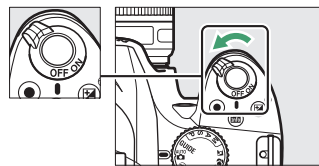

The Microphone and Speaker

Do not place the microphone or speaker in close proximity to magnetic devices. Failure to observe this precaution could affect the data recorded on the magnetic devices.

The Mode Dial

The camera offers a choice of the following shooting modes and **GUIDE** mode:

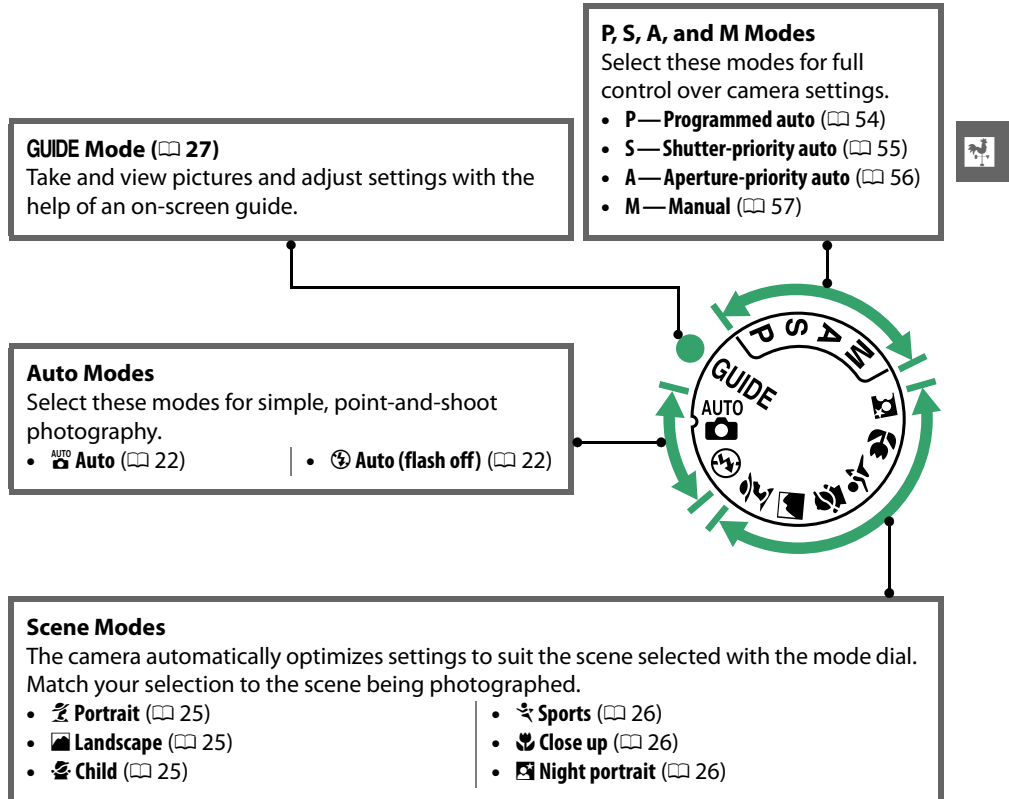

Scene Auto Selector (Live View)

Selecting live view in **AUTO** or **Auto (flash off)** mode enables automatic scene selection (“scene auto selector”; ☞ 85) when autofocus is used.

The Viewfinder

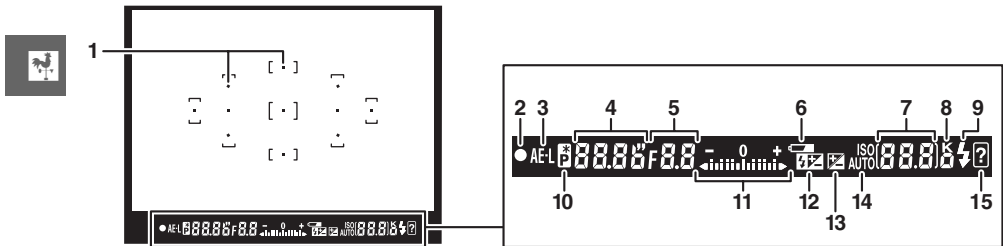
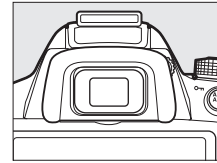

<p>1 Focus points 40</p> <p>2 Focus indicator23, 42</p> <p>3 Autoexposure (AE) lock indicator..... 61</p> <p>4 Shutter speed55, 57</p> <p>5 Aperture (f-number)56, 57</p> <p>6 Battery indicator 21</p>	<p>7 Number of exposures remaining21</p> <p>Number of shots remaining before memory buffer fills 32</p> <p>White balance recording indicator 72</p> <p>Exposure compensation value 63</p> <p>Flash compensation value65</p> <p>ISO sensitivity51</p> <p>8 "K" (appears when memory remains for over 1000 exposures) 21</p>	<p>9 Flash-ready indicator24</p> <p>10 Flexible program indicator 54</p> <p>11 Exposure indicator57</p> <p>Exposure compensation display64</p> <p>Electronic rangefinder.....142</p> <p>12 Flash compensation indicator65</p> <p>13 Exposure compensation indicator63</p> <p>14 Auto ISO sensitivity indicator129</p> <p>15 Warning indicator.....193</p>
---	--	--

✓ The Viewfinder

The response time and brightness of the viewfinder display may vary with temperature.

The Information Display

Camera settings can be viewed and adjusted in the information display. Press the **?** button once to view settings, and again to make changes to settings. Highlight items using the multi-selector and press **OK** to view options for the highlighted item.

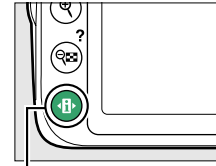

? button

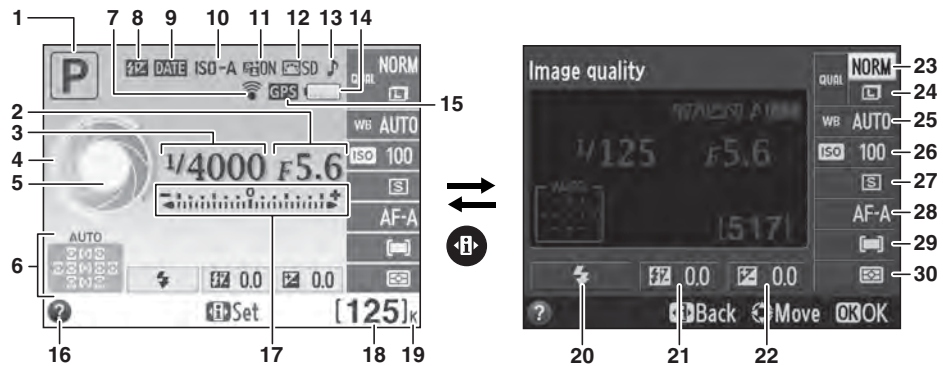

1 Shooting mode <i>auto</i> auto/ <i>auto</i> (flash off)22 Scene modes25 Guide mode27 P, S, A, and M modes.....53	10 Auto ISO sensitivity indicator 129	20 Flash mode 48
2 Aperture (f-number) 56, 57	11 Active D-Lighting..... 67	21 Flash compensation 65
3 Shutter speed55, 57	12 Picture Control..... 76	22 Exposure compensation 63
4 Shutter-speed display6	13 "Beep" indicator 141	23 Image quality 44
5 Aperture display6	14 Battery indicator 21	24 Image size46
6 Auto-area AF indicator38 3D-tracking indicator.....38 Focus point.....40	15 GPS connection indicator .. 147	25 White balance69
7 Eye-Fi connection indicator..... 148	16 Help icon 193	26 ISO sensitivity..... 51
8 Manual flash indicator..... 132 Flash compensation indicator for optional flash units... 175	17 Exposure indicator..... 57 Exposure compensation indicator 64	27 Release mode..... 31
9 Print date indicator..... 144	18 Number of exposures remaining 21 White balance recording indicator 72	28 Focus mode 35, 81
	19 "K" (appears when memory remains for over 1000 exposures) 21	29 AF-area mode..... 38, 82
		30 Metering 60



Hiding Shooting Information

To turn the monitor off, press the **Info** button. Note that the monitor turns off automatically while the shutter-release button is pressed or if no operations are performed for about 8 s (for information on choosing how long the monitor stays on, see **Auto off timers** on page 140). The information display can be restored by pressing the **Info** button again.

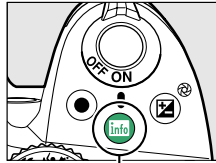

Info button



Information display



Monitor off

Rotating the Camera

When the camera is rotated 90°, shooting information rotates to match camera orientation.

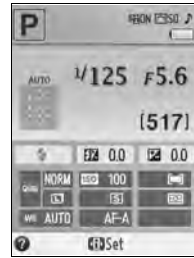

The Shutter-Speed and Aperture Displays

These displays provide visual indications of shutter speed and aperture.

*Fast shutter speed, large aperture
(low f-number).*



*Slow shutter speed, small aperture
(high f-number).*



While the mode dial is rotated, this display is replaced by an image of the mode dial.

See Also

For information on choosing a design for the information display, see **Info display format** (□ 134). For information on choosing whether information is displayed when the shutter-release button is pressed; see **Auto info display** (□ 136). For information on the indicators displayed in live view, see page 84.

The Command Dial

The command dial can be used with other controls to adjust a variety of settings when shooting information is displayed in the monitor.

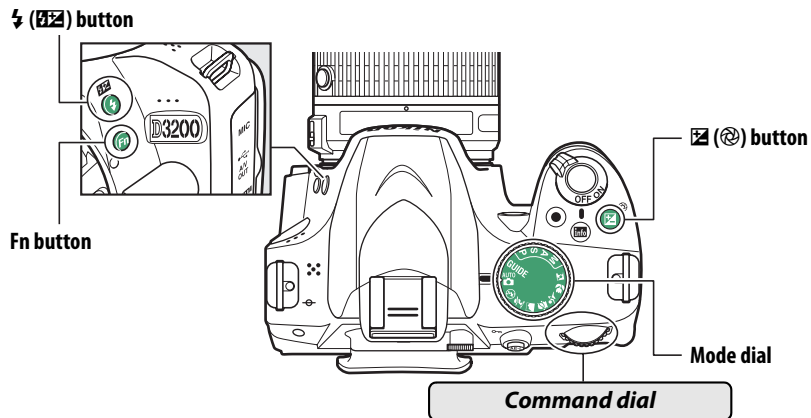

<p>Choose a combination of aperture and shutter speed (mode P; □ 54).</p>	<p>Mode P</p>	<p>Command dial</p>	<p>Information display</p>
<p>Choose a shutter speed (mode S or M; □ 55, 57).</p>	<p>Mode S or M</p>	<p>Command dial</p>	<p>Information display</p>
<p>Choose an aperture (mode A; □ 56).</p>	<p>Mode A</p>	<p>Command dial</p>	<p>Information display</p>
<p>Choose an aperture (mode M; □ 57).</p>	<p>Mode M</p>	<p>Fn button + Command dial</p>	<p>Information display</p>



Set exposure compensation (mode P, S, or A; □ 63).

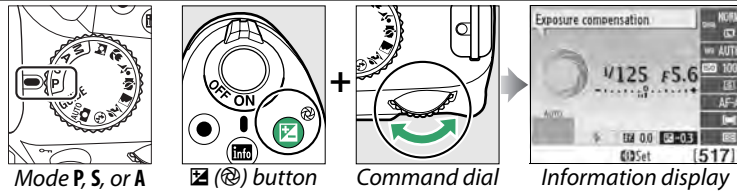

Choose a flash mode (□ 49).

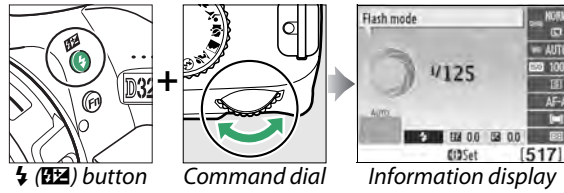

Adjust flash compensation (mode P, S, A, or M; □ 65).

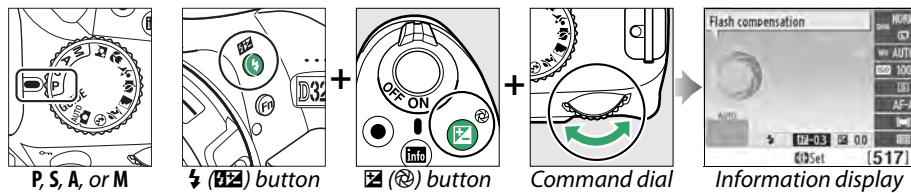

The role of the **Fn** button can be selected using the **Buttons > Assign Fn button** option in the setup menu (□ 143), allowing the following settings to be adjusted by pressing the **Fn** button and rotating the command dial:

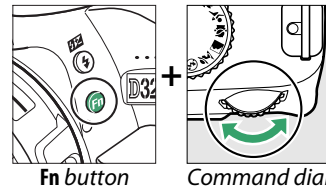

Image quality/size (□ 44)



ISO sensitivity (□ 51)



White balance (□ 69)

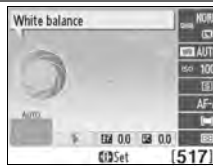

Active D-Lighting (□ 67)



Camera Menu

Most shooting, playback, and setup options can be accessed from the camera menu. To view the menus, press the **MENU** button.

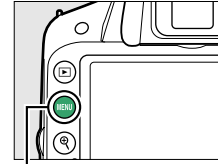

MENU button



Tabs

Choose from the following menus:

- : **Playback** (☞ 125)
- : **Shooting** (☞ 127)
- : **Setup** (☞ 133)
- : **Retouch** (☞ 149)
- : **Recent settings** (☞ 166)

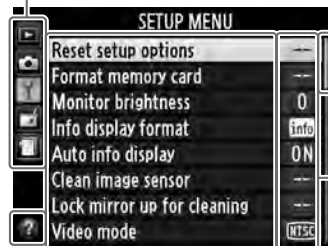

Slider shows position in current menu.

Current settings are shown by icons.

Menu options

Options in current menu.



If a icon is displayed at the bottom left corner of the monitor, help can be displayed by pressing the () button. A description of the currently selected option or menu will be displayed while the button is pressed. Press or to scroll through the display.

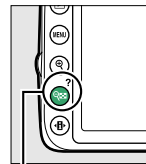

() button

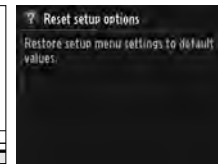

Guide Mode

To display the on-screen guide, rotate the mode dial to **GUIDE** (☞ 27).

Using Camera Menus

The multi selector and **OK** button are used to navigate the camera menus.

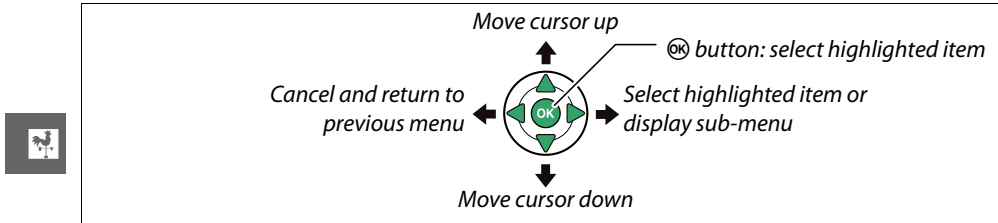

Follow the steps below to navigate the menus.

1 Display the menus.

Press the **MENU** button to display the menus.

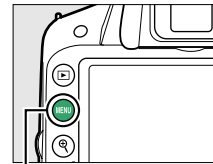

MENU button

2 Highlight the icon for the current menu.

Press **◀** to highlight the icon for the current menu.



3 Select a menu.

Press **▲** or **▼** to select the desired menu.

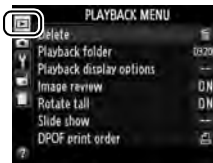
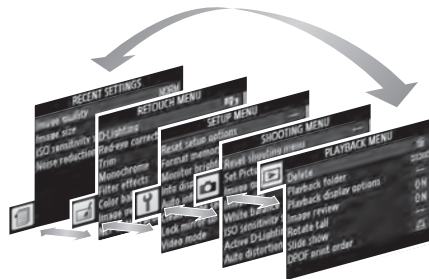

4 Position the cursor in the selected menu.

Press **▶** to position the cursor in the selected menu.

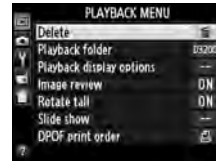

5 Highlight a menu item.

Press **▲** or **▼** to highlight a menu item.

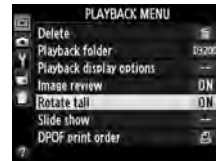

6 Display options.

Press **▶** to display options for the selected menu item.



7 Highlight an option.

Press **▲** or **▼** to highlight an option.



8 Select the highlighted item.

Press **OK** to select the highlighted item. To exit without making a selection, press the **MENU** button.



Note the following:

- Menu items that are displayed in gray are not currently available.
- While pressing **▶** generally has the same effect as pressing **OK**, there are some cases in which selection can only be made by pressing **OK**.
- To exit the menus and return to shooting mode, press the shutter-release button halfway (□ 24).

First Steps

Charge the Battery

The camera is powered by an EN-EL14 rechargeable Li-ion battery (supplied). To maximize shooting time, charge the battery in the supplied MH-24 battery charger before use. About 1 hour and 30 minutes are required to fully recharge the battery when no charge remains.



The Plug Adapter

Depending on the country or region of purchase, a plug adapter may be supplied with the charger. The shape of the adapter varies with the country or region of purchase. If a plug adapter is supplied, raise the wall plug and connect the plug adapter as shown at right, making sure the plug is fully inserted. Attempting to forcibly remove the plug adapter could damage the product.

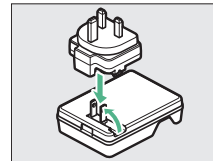

1 Remove the terminal cover.

Remove the terminal cover from the battery.

2 Insert the battery.

Insert the battery as shown in the illustration on the charger.

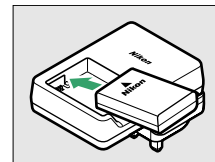

Charging the Battery

Charge the battery indoors at ambient temperatures between 5–35 °C (41–95 °F). The battery will not charge if its temperature is below 0 °C (32 °F) or above 60 °C (140 °F).

3 Plug the charger in.

The **CHARGE** lamp will flash slowly while the battery charges.

During Charging

Do not move the charger or touch the battery during charging. Failure to observe this precaution could in very rare instances result in the charger showing that charging is complete when the battery is only partially charged. Remove and reinsert the battery to begin charging again.

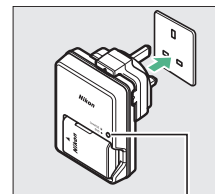

Battery charging *Charging complete*

4 Remove the battery when charging is complete.

Charging is complete when the **CHARGE** lamp stops flashing. Unplug the charger and remove the battery.

Insert the Battery

1 Turn the camera off.

Inserting and Removing Batteries

Always turn the camera off before inserting or removing batteries.

2 Open the battery-chamber cover.

Unlatch (1) and open (2) the battery-chamber cover.

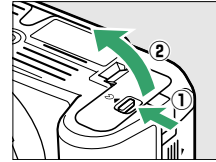

3 Insert the battery.

Insert the battery in the orientation shown (3), using the battery to keep the orange battery latch pressed to one side. The latch locks the battery in place when the battery is fully inserted.

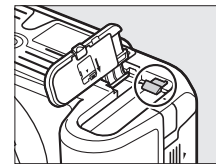
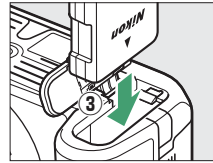

Battery latch

4 Close the battery-chamber cover.

Removing the Battery

Turn the camera off and open the battery-chamber cover. Press the battery latch in the direction shown by the arrow to release the battery and then remove the battery by hand.

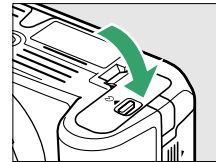
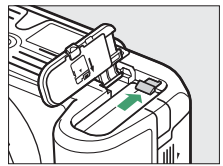

The Battery and Charger

Read and follow the warnings and cautions on pages ix–x and 184–186 of this manual. Do not use the battery at ambient temperatures below 0°C/32°F or above 40°C/104°F; failure to observe this precaution could damage the battery or impair its performance. Capacity may be reduced and charging times may increase at battery temperatures from 0°C/32°F to 15°C/59°F and from 45°C/113°F to 60°C/140°F. If the **CHARGE** lamp flashes quickly (about eight times a second) during charging, confirm that the temperature is in the correct range and then unplug the charger and remove and reinsert the battery. If the problem persists, cease use immediately and take battery and charger to your retailer or a Nikon-authorized service representative.

Do not attempt to charge a fully-charged battery. Failure to observe this precaution will result in reduced battery performance.

Use the charger with compatible batteries only. Unplug when not in use.

Attach a Lens

Care should be taken to prevent dust from entering the camera when the lens is removed. The lens generally used in this manual for illustrative purposes is an AF-S DX NIKKOR 18–55mm f/3.5–5.6G VR II.

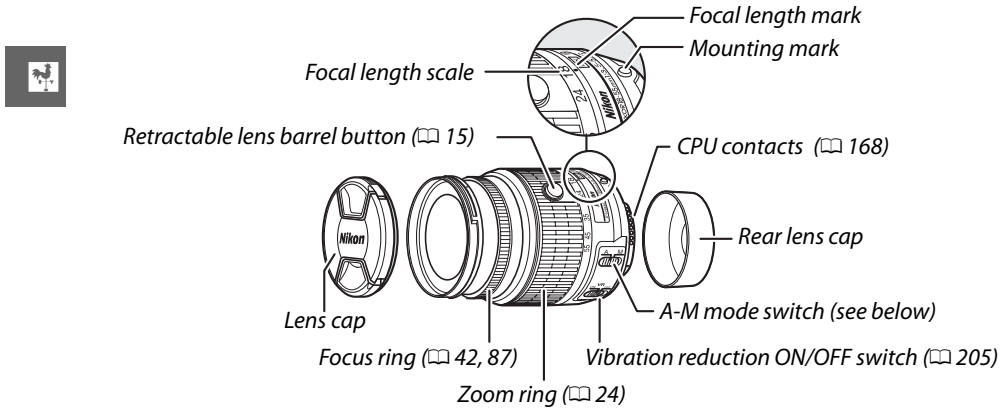

1 Turn the camera off.

2 Remove the rear lens cap and the camera body cap.

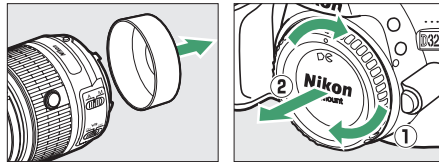

3 Attach the lens.

Keeping the mounting mark on the lens aligned with the mounting mark on the camera body, position the lens in the camera's bayonet mount (①). Being careful not to press the lens-release button, rotate the lens counter-clockwise until it clicks into place (②).

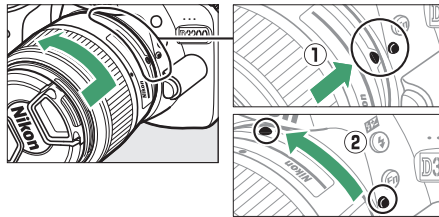

Slide the **A-M** mode switch to **A** (autofocus; if the lens has an **M/A-M** mode switch, select **M/A** for autofocus with manual override).



If the lens has a vibration reduction (VR) switch, select **ON** to reduce the effects of vibration (with a book icon and number 205).

✔ Lenses with Retractable Lens Barrel Buttons

Before using the camera, unlock and extend the zoom ring. Keeping the retractable lens barrel button pressed (①), rotate the zoom ring as shown (②).

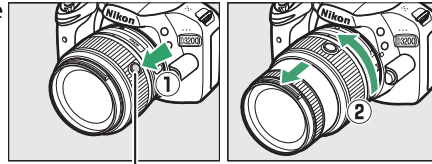

Retractable lens barrel button

Pictures can not be taken when the lens is retracted; if an error message is displayed as a result of the camera having been turned on with the lens retracted, rotate the zoom ring until the message is no longer displayed.

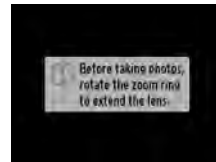

✔ Autofocus

Autofocus is supported with only AF-S and AF-I lenses, which are equipped with autofocus motors. Autofocus is not available with other AF lenses (☞ 167).

✔ CPU Lenses with Aperture Rings

In the case of CPU lenses equipped with an aperture ring (☞ 168), lock aperture at the minimum setting (highest f-number).

✔ Detaching the Lens

Be sure the camera is off when removing or exchanging lenses. To remove the lens, press and hold the lens release button (①) while turning the lens clockwise (②). After removing the lens, replace the lens caps and camera body cap.

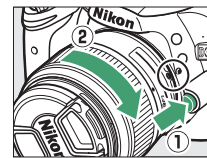

✔ Retracting Lenses with Retractable Lens Barrel Buttons

To retract the lens when the camera is not in use, hold the retractable lens barrel button (①) and rotate the zoom ring to the "L" (lock) position as shown (②). Retract the lens before removing it from the camera, and be careful not to press the retractable lens barrel button when attaching or removing the lens.



Basic Setup

A language-selection dialog will be displayed the first time the camera is turned on. Choose a language and set the time and date. Photographs can not be taken until you have set the time and date.



1 Turn the camera on.

A language-selection dialog will be displayed.

2 Select a language.

Press ▲ or ▼ to highlight the desired language and press **OK**.



3 Choose a time zone.

A time-zone selection dialog will be displayed. Press ◀ or ▶ to highlight the local time zone (the **UTC** field shows the difference between the selected time zone and Coordinated Universal Time, or UTC, in hours) and press **OK**.



4 Choose a date format.

Press ▲ or ▼ to choose the order in which the year, month, and day will be displayed. Press **OK** to proceed to the next step.

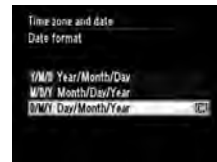

5 Turn daylight saving time on or off.

Daylight saving time options will be displayed. Daylight saving time is off by default; if daylight saving time is in effect in the local time zone, press ▲ to highlight **On** and press **OK**.



6 Set the date and time.

The dialog shown at right will be displayed. Press ◀ or ▶ to select an item, ▲ or ▼ to change. Press **OK** to set the clock and exit to shooting mode.

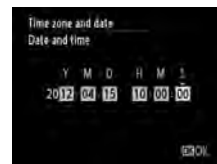

 **The Clock Battery**

The camera clock is powered by an independent, rechargeable power source, which is charged as necessary when the main battery is installed or the camera is powered by an optional EP-5A power connector and EH-5b AC adapter (□ 178). Three days of charging will power the clock for about a month. If a message warning that the clock is not set is displayed when the camera is turned on, the clock battery is exhausted and the clock has been reset. Set the clock to the correct time and date.

 **The Camera Clock**

The camera clock is less accurate than most watches and household clocks. Check the clock regularly against more accurate time pieces and reset as necessary.

 **The Setup Menu**

Language and date/time settings can be changed at any time using the **Language** (□ 137) and **Time zone and date** (□ 137) options in the setup menu.



Insert a Memory Card

The camera stores pictures on Secure Digital (SD) memory cards (available separately;  177).

1 Turn the camera off.



Inserting and Removing Memory Cards

Always turn the camera off before inserting or removing memory cards.

2 Open the card slot cover.

Slide the card slot cover out (1) and open the card slot (2).

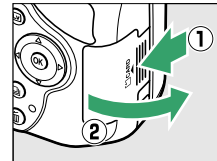

3 Insert the memory card.

Holding the memory card as shown at right, slide it in until it clicks into place. The memory card access lamp will light for a few seconds. Close the memory card slot cover.

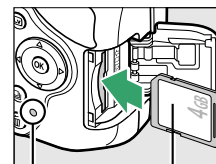

Front

Memory card access lamp

Inserting Memory Cards

Inserting memory cards upside down or backwards could damage the camera or the card. Check to be sure the card is in the correct orientation.

If this is the first time the memory card will be used in the camera or the card has been formatted in another device, format the card as described on page 19.

Removing Memory Cards

After confirming that the memory card access lamp is off, turn the camera off, open the memory card slot cover, and press the card in to eject it (1). The card can then be removed by hand (2).

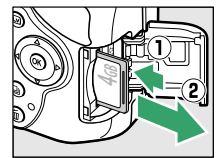

The Write Protect Switch

SD memory cards are equipped with a write protect switch to prevent accidental loss of data. When this switch is in the "lock" position, the memory card can not be formatted and photos can not be deleted or recorded (a beep will sound if you attempt to release the shutter). To unlock the memory card, slide the switch to the "write" position.

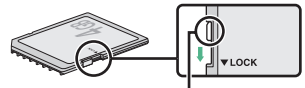

Write-protect switch

Format the Memory Card

Memory cards must be formatted before first use or after being formatted in other devices. Format the card as described below.

✓ Formatting Memory Cards

Formatting memory cards permanently deletes any data they may contain. Be sure to copy any photographs and other data you wish to keep to a computer before proceeding (111).

1 Turn the camera on.

2 Display format options.

Press the **MENU** button to display the menus. Highlight **Format memory card** in the setup menu and press **▶**. For more information on using the menus, see page 9.

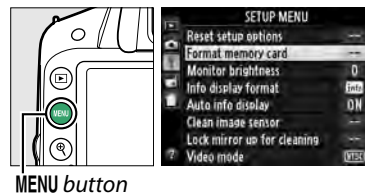

3 Highlight Yes.

To exit without formatting the memory card, highlight **No** and press **OK**.

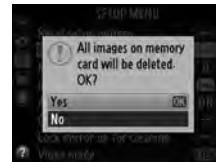

4 Press OK.

The message at right will be displayed while the card is formatted. *Do not remove the memory card or remove or disconnect the power source until formatting is complete.*

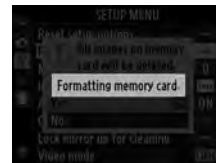

✓ Memory Cards

- Memory cards may be hot after use. Observe due caution when removing memory cards from the camera.
- Turn the power off before inserting or removing memory cards. Do not remove memory cards from the camera, turn the camera off, or remove or disconnect the power source during formatting or while data are being recorded, deleted, or copied to a computer. Failure to observe these precautions could result in loss of data or in damage to the camera or card.
- Do not touch the card terminals with your fingers or metal objects.
- Do not bend, drop, or subject to strong physical shocks.
- Do not apply force to the card casing. Failure to observe this precaution could damage the card.
- Do not expose to water, heat, high levels of humidity, or direct sunlight.
- Do not format memory cards in a computer.



Adjust Viewfinder Focus

The camera is equipped with diopter adjustment to accommodate individual differences in vision. Check that the display in the viewfinder is in focus before framing pictures in the viewfinder.



1 Remove the lens cap.

2 Turn the camera on.



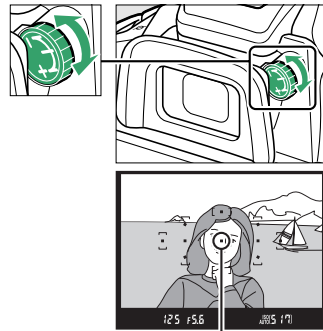

3 Focus the viewfinder.

Rotate the diopter adjustment control until the viewfinder display and focus point are in sharp focus. When operating the control with your eye to the viewfinder, be careful not to put your fingers or fingernails in your eye.



Focus point

Adjusting Viewfinder Focus

If you are unable to focus the viewfinder as described above, select single-servo autofocus (AF-S;  35), single-point AF (L+;  38), and the center focus point ( 40), and then frame a high-contrast subject in the center focus point and press the shutter-release button halfway to focus the camera. With the camera in focus, use the diopter adjustment control to bring the subject into clear focus in the viewfinder. If necessary, viewfinder focus can be further adjusted using optional corrective lenses ( 176).



Basic Photography

Battery Level and Card Capacity

Before shooting, check the battery level and number of exposures remaining.

1 Turn the camera on.

2 Check the battery level.

Check the battery level in the information display (if the battery is low, a warning will also be displayed in the viewfinder). If the monitor is off, press the button to view the information display; if the monitor does not turn on, the battery is exhausted and must be recharged.



Information display	Viewfinder	Description
	—	Battery fully charged.
	—	Battery partially discharged.
		Low battery. Ready fully-charged spare battery or prepare to charge battery.
 (flashes)	 (flashes)	Battery exhausted; shutter release disabled. Charge or exchange battery.

3 Check the number of exposures remaining.

The information display and viewfinder show the number of photographs that can be taken at current settings (values over 1,000 are rounded down to the nearest hundred; e.g., values between 1,200 and 1,299 are shown as 1.2 K). If a warning is displayed stating that there is not enough memory for additional photographs, insert another memory card (18) or delete some photos (106).



“Point-and-Shoot” Photography

(^{AUTO} and Modes)

This section describes how to take photographs in ^{AUTO} and  modes, automatic “point-and-shoot” modes in which the majority of settings are controlled by the camera in response to shooting conditions.



1 Turn the camera on.

Remove the lens cap and turn the camera on. The information display will appear in the monitor.

2 Select ^{AUTO} or mode.

To shoot where use of a flash is prohibited, photograph infants, or capture natural lighting under low light, select auto (flash off) mode by rotating the mode dial to . Otherwise, rotate the dial to ^{AUTO} (auto).

Mode dial

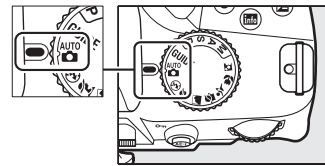

3 Ready the camera.

When framing photographs in the viewfinder, hold the handgrip in your right hand and cradle the camera body or lens with your left. Keep your elbows propped lightly against your torso for support and place one foot half a pace ahead of the other to keep your upper body stable. When framing photographs in portrait (tall) orientation, hold the camera as shown at right.

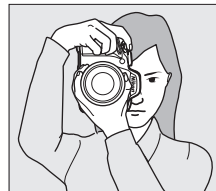
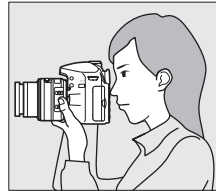
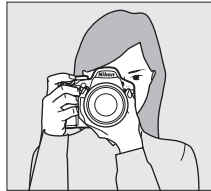

In  mode, shutter speeds slow when lighting is poor; use of a tripod is recommended.

4 Frame the photograph.

Frame a photograph in the viewfinder with the main subject in at least one of the 11 focus points.

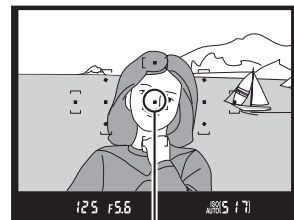

Focus point

5 Press the shutter-release button halfway.

Press the shutter-release button halfway to focus. The camera will select the focus points automatically. If the subject is poorly lit, the flash may pop up and the AF-assist illuminator may light.



6 Check the indicators in the viewfinder.

When the focus operation is complete, the selected focus points will be briefly highlighted, a beep will sound (a beep may not sound if the subject is moving), and the in-focus indicator (●) will appear in the viewfinder.

In-focus indicator	Description
●	Subject in focus.
● (flashes)	Camera unable to focus using autofocus. See page 36.

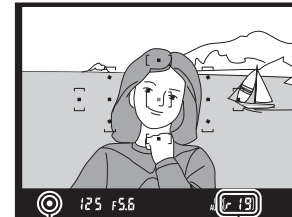

In-focus indicator

Buffer capacity

While the shutter-release button is pressed halfway, the number of exposures that can be stored in the memory buffer ("32"; □ 32) will be displayed in the viewfinder.

7 Shoot.

Smoothly press the shutter-release button the rest of the way down to release the shutter and record the photograph. The memory card access lamp will light and the photograph will be displayed in the monitor for a few seconds (the photo will automatically clear from the display when the shutter-release button is pressed halfway). *Do not eject the memory card or remove or disconnect the power source until the lamp has gone out and recording is complete.*

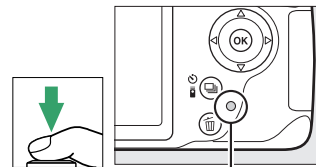

Memory card access lamp



Image Sensor Cleaning

The camera vibrates the low-pass filter covering the image sensor to remove dust when the camera is turned on or off (□ 180).



The Shutter-Release Button

The camera has a two-stage shutter-release button. The camera focuses when the shutter-release button is pressed halfway. To take the photograph, press the shutter-release button the rest of the way down.

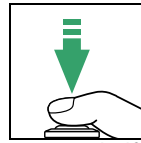
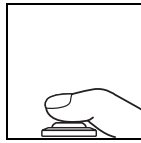

Focus: press halfway

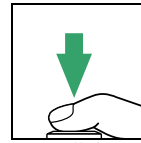

Shoot: press all the way down

The Standby Timer

The viewfinder and information display will turn off if no operations are performed for about 8 seconds, reducing the drain on the battery. Press the shutter-release button halfway to reactivate the display. The length of time before the standby timer expires automatically can be selected using the **Auto off timers** option in the setup menu (□ 140).

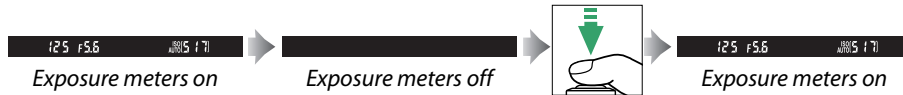

The Built-in Flash

If additional lighting is required for correct exposure in **AUTO** mode, the built-in flash will pop up automatically when the shutter-release button is pressed halfway (□ 47). If the flash is raised, photographs can only be taken when the flash-ready indicator (⚡) is displayed. If the flash-ready indicator is not displayed, the flash is charging; remove your finger briefly from the shutter-release button and try again.

To save battery power when the flash is not in use, return it to its closed position by pressing it gently downward till the latch clicks into place.

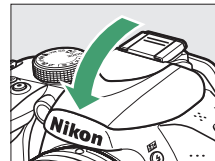
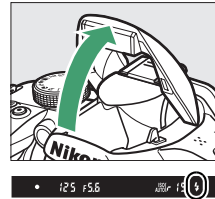

Using a Zoom Lens

Use the zoom ring to zoom in on the subject so that it fills a larger area of the frame, or zoom out to increase the area visible in the final photograph (select longer focal lengths on the lens focal length scale to zoom in, shorter focal lengths to zoom out). If the lens is equipped with a retractable lens barrel button (□ 15), press and hold the button while rotating the zoom ring until the lens is released and a warning message is no longer displayed, and then adjust zoom using the zoom ring.

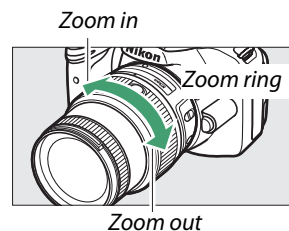

Creative Photography (Scene Modes)

The camera offers a choice of “scene” modes. Choosing a scene mode automatically optimizes settings to suit the selected scene, making creative photography as simple as selecting a mode, framing a picture, and shooting as described on pages 22–24.

The following scenes can be selected with the mode dial:

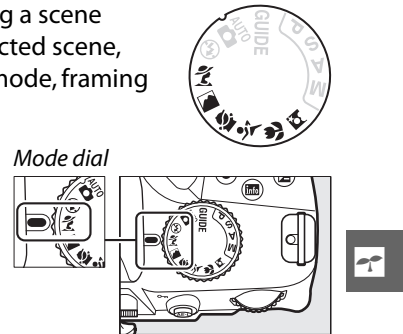

Portrait



Use for portraits with soft, natural-looking skin tones. If the subject is far from the background or a telephoto lens is used, background details will be softened to lend the composition a sense of depth.

Landscape



Use for vivid landscape shots in daylight. The built-in flash and AF-assist illuminator turn off; use of a tripod is recommended to prevent blur when lighting is poor.

Child



Use for snapshots of children. Clothing and background details are vividly rendered, while skin tones remain soft and natural.

 **Sports**



Fast shutter speeds freeze motion for dynamic sports shots in which the main subject stands out clearly. The built-in flash and AF-assist illuminator turn off.



 **Close up**



Use for close-up shots of flowers, insects, and other small objects (a macro lens can be used to focus at very close ranges). Use of a tripod is recommended to prevent blur.

 **Night Portrait**



Use for a natural balance between the main subject and the background in portraits taken under low light. Use of a tripod is recommended to prevent blur.

G Guide Mode

The Guide

Guide mode gives access to a variety of frequently-used and useful functions. The top level of the guide is displayed when the mode dial is rotated to **GUIDE**.



Battery indicator (☰ 21)

Number of exposures remaining (☰ 21)

Shooting mode: A guide mode indicator appears on the shooting mode icon.

Choose from the following items:

Shoot	View/delete	Set up
Take pictures.	View and/or delete pictures.	Change camera settings.

Guide Mode Menus

To access these menus, highlight **Shoot**, **View/delete**, or **Set up** and press **OK**.



Shoot

G

Easy operation
Auto
No flash
Distant subjects
Close-ups
Sleeping faces
Moving subjects
Landscapes
Portraits
Night portrait

Advanced operation	
Soften backgrounds	Adjust aperture.
Bring more into focus	
Freeze motion (people)	Select a shutter speed.
Freeze motion (vehicles)	
Show water flowing	
Capture reds in sunsets*	Adjust white balance to vividly capture the colors in sunsets.
Take bright photos*	Adjust exposure compensation to take bright (high key) or dark (low key) photos.
Take dark (low key) photos*	
Reduce blur	Adjust auto ISO sensitivity control for poorly lit subjects or telephoto lenses.

* Affects other **Advanced operation** items. To restore default settings, turn the camera off and then on again.

“Start Shooting”

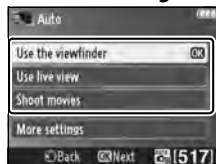

Highlight an option and press **OK**.

- Use the viewfinder
- Use live view
- Shoot movies

“More Settings”

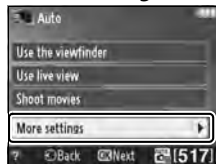

If **More settings** is displayed, you can highlight this option and press **▶** to access the following settings (the settings available vary with the shooting option selected):

- Flash settings > Flash mode
- Flash settings > Flash compensation
- Release mode
- ISO sensitivity settings > ISO sensitivity
- ISO sensitivity settings > Auto ISO sensitivity control
- Set Picture Control
- Exposure compensation
- White balance

■ ■ View/Delete

View single photos

View multiple photos

Choose a date

View a slide show

Delete photos

■ ■ Set Up

Image quality

Image size

Auto off timers

Print date

Display and sound settings

Monitor brightness

Info background color

Auto info display

Beep

Movie settings

Frame size/frame rate

Movie quality

Microphone

Flicker reduction

Output settings

HDMI

Video mode

Playback folder

Playback display options

DPOF print order

Clock and language

Time zone and date

Language

Format memory card

Eye-Fi upload *

Slot empty release lock

G

* Only available when compatible Eye-Fi memory card is inserted (p. 148).









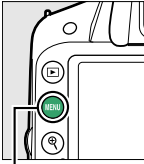

Changes to **Image quality, Image size, Auto off timers, Print date, Playback folder, Playback display options**, all **Display and sound settings** options, and all **Movie settings** options except **Flicker reduction** apply in guide mode only and are not reflected in other shooting modes.

Guide Mode

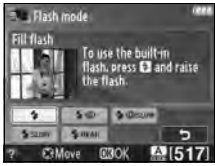
Guide mode is reset to **Easy operation > Auto** when the mode dial is rotated to another setting or the camera is turned off.

Using the Guide

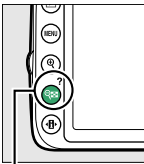
The following operations can be performed while the guide is displayed:

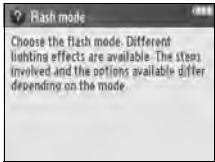





To	Use	Description
Return to top level of guide	 MENU button	Press MENU to turn the monitor on or return to the top level of the guide.
Turn monitor on		
G Highlight a menu		Press ◀ or ▶ to highlight a menu.
Highlight options		Press ▲ or ▼ to highlight options in the menus.
		Press ▲, ▼, ◀, or ▶ to highlight options in displays like that shown at right. 
Select highlighted menu or option		Press OK to select the highlighted menu or option.
Return to previous display		Press ◀ to return to the previous display.
		To cancel and return to the previous display from displays like that shown at right, highlight ↶ and press OK. 
View help	 ⓘ (?) button	<p>If a ⓘ icon is displayed at the bottom left corner of the monitor, help can be displayed by pressing the ⓘ (?) button. A description of the currently selected option will be displayed while the button is pressed. Press ▲ or ▼ to scroll through the display.</p>  ⓘ (help) icon 



More on Photography (All Modes)

Release Mode



Choose from the following release modes:

Mode	Description
	Single frame: Camera takes one photograph each time shutter-release button is pressed.
	Continuous: While shutter-release button is held down, camera records up to 4 frames per second.
	Self-timer: Use self-timer for self-portraits or to reduce blurring caused by camera shake (□ 33).
 2s	Delayed remote: Shutter is released 2 s after shutter-release button on optional ML-L3 (□ 177) remote control is pressed (□ 33).
	Quick-response remote: Shutter is released when shutter-release button on optional ML-L3 (□ 177) remote control is pressed (□ 33).
	Quiet shutter release: As for single frame, except that mirror does not click back into place while shutter-release button is fully pressed, allowing user to control timing of click made by mirror, which is also quieter than in single frame mode. Also, beep does not sound when camera focuses, keeping noise to a minimum in quiet surroundings.

1 Press (/).

A list of release mode options will be displayed.



 (/) button

2 Choose a release mode.

Highlight a release mode and press  to return to the information display. Photographs can be taken immediately.





The Memory Buffer

The camera is equipped with a memory buffer for temporary storage, allowing shooting to continue while photographs are being saved to the memory card. Up to 100 photographs can be taken in succession; note, however, that frame rate will drop when the buffer is full.

While photographs are being recorded to the memory card, the memory card access lamp will light (□ 2). Depending on the number of the images in the buffer, recording may take from a few seconds to a few minutes. *Do not remove the memory card or remove or disconnect the power source until the access lamp has gone out.* If the camera is switched off while data remain in the buffer, the power will not turn off until all images in the buffer have been recorded. If the battery is exhausted while images remain in the buffer, the shutter release will be disabled and the images transferred to the memory card.

Continuous Release Mode

Continuous release mode (□ 1) can not be used with the built-in flash; rotate the mode dial to (□ 22) or turn the flash off (□ 47–49). For information on the number of photographs that can be taken in a single burst, see page 188.

Buffer Size

The approximate number of images that can be stored in the memory buffer at current settings is shown in the viewfinder exposure-count display while the shutter-release button is pressed. The illustration shows the display when space remains in the buffer for about 19 pictures.



The Information Display

The release mode can also be selected using the **Release mode** option in the information display (□ 5).





Self-Timer and Remote Control Modes

The self-timer and optional ML-L3 remote control (☐ 177) allow the photographer to be at a distance from the camera when a photo is taken.

1 Mount the camera on a tripod.

Mount the camera on a tripod or place the camera on a stable, level surface.

2 Select a release mode.

Select  (self-timer),  2s (delayed remote), or  (quick-response remote) mode (☐ 31; note that if no operations are performed for about a minute after a remote control mode is selected, the camera will automatically return to single frame, continuous, or quiet shutter-release mode).

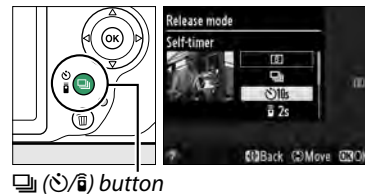

3 Frame the photograph.

Remote control mode: Check focus by pressing the shutter-release button halfway. No photograph will be taken even if the button is pressed all the way down.

4 Take the photograph.

Self-timer mode: Press the shutter-release button halfway to focus, and then press the button the rest of the way down. The self-timer lamp will start to flash and a beep will begin to sound. Two seconds before the photo is taken, the lamp will stop flashing and the beeping will become more rapid. The shutter will be released ten seconds after the timer starts.

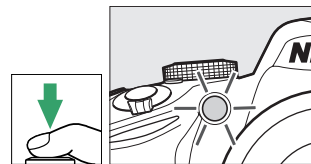

Remote control mode: From a distance of 5 m (16 ft) or less, aim the transmitter on the ML-L3 at either of the infrared receivers on the camera (☐ 1, 2) and press the ML-L3 shutter-release button. *In delayed remote mode*, the self-timer lamp will light for about two seconds before the shutter is released. *In quick-response remote mode*, the self-timer lamp will flash after the shutter has been released.

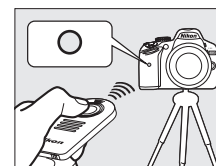

Note that the timer may not start or a photograph may not be taken if the camera is unable to focus or in other situations in which the shutter can not be released. Turning the camera off cancels self-timer and remote control release modes and restores single frame, continuous, or quiet shutter-release mode.

✓ Before Using the Remote Control

Before using the remote control for the first time, remove the clear plastic battery-insulator sheet.

✍ Cover the Viewfinder

When taking photos without your eye to the viewfinder, remove the DK-20 rubber eyecup (1) and insert the supplied DK-5 eyepiece cap as shown (2). This prevents light entering via the viewfinder interfering with exposure. Hold the camera firmly when removing the rubber eyecup.

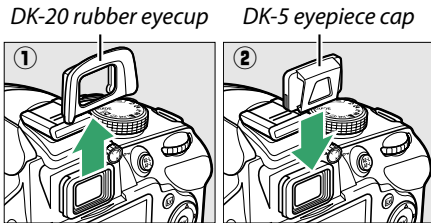

✓ Using the Built-in Flash

Before taking a photograph with the flash in **P**, **S**, **A**, or **M** modes, press the **⚡** (**24**) button to raise the flash and wait for the **⚡** indicator to be displayed in the viewfinder (□ 24). Shooting will be interrupted if the flash is raised while a remote control mode is in effect or after the self-timer has started. If the flash is required, the camera will only respond to the ML-L3 shutter-release button once the flash has charged. In auto or scene modes in which the flash pops up automatically, the flash will begin charging when a remote control mode is selected; once the flash is charged, it will automatically pop up and fire when required.

In flash modes that support red-eye reduction, the red-eye reduction lamp will light for about one second before the shutter is released in quick-response remote mode. In delayed remote mode, the self-timer lamp will light for two seconds, followed by the red-eye reduction lamp which lights for one second before the shutter is released.

✍ See Also

For information on choosing the duration of the self-timer and the number of shots taken, see the **Self-timer** option in the setup menu (□ 141). For information on choosing how long the camera will wait for a signal from the remote, see the **Remote on duration** option in the setup menu (□ 141). For information on controlling the beeps that sound when the self-timer and remote control are used, see the **Beep** option in the setup menu (□ 141).



Focus



This section describes the focus options available when photographs are framed in the viewfinder. Focus can be adjusted automatically or manually (see “Focus Mode,” below). The user can also select the focus point for automatic or manual focus (📖 42) or use focus lock to focus to recompose photographs after focusing (📖 40).

Focus Mode

Choose from the following focus modes. Note that **AF-S** and **AF-C** are available only in modes **P**, **S**, **A**, and **M**.

Option	Description
AF-A Auto-servo AF	Camera automatically selects single-servo autofocus if subject is stationary, continuous-servo autofocus if subject is moving. Shutter can only be released if camera is able to focus.
AF-S Single-servo AF	For stationary subjects. Focus locks when shutter-release button is pressed halfway. Shutter can only be released if camera is able to focus.
AF-C Continuous-servo AF	For moving subjects. Camera focuses continuously while shutter-release button is pressed halfway. Shutter can only be released if camera is able to focus.
MF Manual focus	Focus manually (📖 42).

1 Place the cursor in the information display.

If shooting information is not displayed in the monitor, press the  button. Press the  button again to place the cursor in the information display.

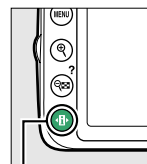

 button



Information display

2 Display focus-mode options.

Highlight the current focus mode in the information display and press .



3 Choose a focus mode.

Highlight a focus mode and press . To return to shooting mode, press the shutter-release button halfway.





Predictive Focus Tracking

In **AF-C** mode or when continuous-servo autofocus is selected in **AF-A** mode, the camera will initiate predictive focus tracking if the subject moves toward the camera while the shutter-release button is pressed halfway. This allows the camera to track focus while attempting to predict where the subject will be when the shutter is released.

Continuous-servo Autofocus

In **AF-C** mode or when continuous-servo autofocus is selected in **AF-A** mode, the camera gives higher priority to focus response (has a wider focus range) than in **AF-S** mode, and the shutter may be released before the in-focus indicator is displayed.

Getting Good Results with Autofocus

Autofocus does not perform well under the conditions listed below. The shutter release may be disabled if the camera is unable to focus under these conditions, or the in-focus indicator (●) may be displayed and the camera may sound a beep, allowing the shutter to be released even when the subject is not in focus. In these cases, focus manually (📖 42) or use focus lock (📖 40) to focus on another subject at the same distance and then recompose the photograph.

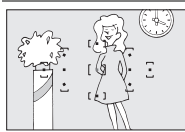

There is little or no contrast between the subject and the background.

Example: Subject is the same color as the background.

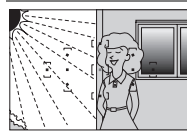

The focus point contains areas of sharply contrasting brightness.

Example: Subject is half in the shade.



The focus point contains objects at different distances from the camera.

Example: Subject is inside a cage.



Background objects appear larger than the subject.

Example: A building is in the frame behind the subject.

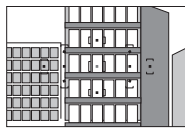

The subject is dominated by regular geometric patterns.

Example: Blinds or a row of windows in a skyscraper.

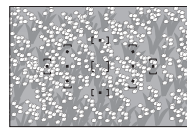

The subject contains many fine details.

Example: A field of flowers or other subjects that are small or lack variation in brightness.

✓ **The AF-Assist Illuminator**

If the subject is poorly lit, the AF-assist illuminator will light automatically to assist the autofocus operation when the shutter-release button is pressed halfway. The AF-assist illuminator will not light:

- In live view or during movie recording
- During manual focus or if live view is off and continuous-servo autofocus is selected (**AF-C** selected for focus mode, or continuous-servo AF selected in **AF-A** focus mode)
- If the center focus point is not selected in [1] (**Single-point AF**), [2] (**Dynamic-area AF**), or [3D] (**3D-tracking (11 points)**) AF-area mode (☐ 38, 40)
- In shooting modes in which the AF-assist illuminator can not be used (☐ 187)
- If **Off** has been selected for the **Built-in AF-assist illuminator** option in the shooting menu (☐ 131)

The illuminator has a range of about 0.5–3.0 m (1 ft 8 in.–9 ft 10 in.); when using the illuminator, use a lens with a focal length of 18–200 mm and remove the lens hood. The AF-assist illuminator will turn off automatically to protect the lamp after a period of continuous use. Normal function will resume after a brief pause. Note that the illuminator may become hot when used multiple times in quick succession.



✓ **See Also**



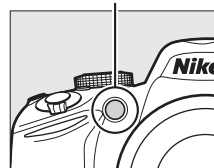



For information on focusing in live view, see page 81. The **Beep** option in the setup menu (☐ 141) can be used to turn the beep speaker on or off.

AF-assist illuminator





AF-Area Mode

Choose how the focus point for autofocus is selected. Note that  (**Dynamic-area AF**) and  (**3D-tracking (11 points)**) are not available when **AF-S** is selected for focus mode.

Option	Description
 Single-point AF	User selects focus point using multi selector ( 40); camera focuses on subject in selected focus point only. Use with stationary subjects.
 Dynamic-area AF	In AF-A and AF-C focus modes , user selects focus point using multi selector ( 40), but camera will focus based on information from surrounding focus points if subject briefly leaves selected point. Use with erratically moving subjects.
 3D-tracking (11 points)	In AF-A and AF-C focus modes , user selects focus point using multi selector ( 40). If subject moves after camera has focused, camera uses 3D-tracking to select new focus point and keep focus locked on original subject while shutter-release button is pressed halfway. If subject leaves viewfinder, remove your finger from shutter-release button and recompose photograph with subject in selected focus point.
 Auto-area AF	Camera automatically detects subject and selects focus point.



1 Place the cursor in the information display.

If shooting information is not displayed in the monitor, press the  button. Press the  button again to place the cursor in the information display.

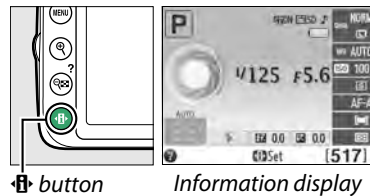

2 Display AF-area mode options.

Highlight the current AF-area mode in the information display and press .



3 Choose an AF-area mode.

Highlight one of the following options and press . To return to shooting mode, press the shutter-release button halfway.



AF-Area Mode

The AF-area mode used when photographs are framed in the viewfinder can also be selected using the **AF-area mode > Viewfinder** option in the shooting menu (📖 127). AF-area mode selections made in shooting modes other than **P**, **S**, **A**, or **M** are reset when another shooting mode is selected.

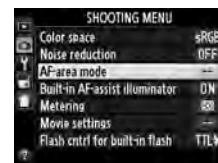

3D-tracking (11 Points)

When the shutter-release button is pressed halfway, the colors in the area surrounding the focus point are stored in the camera. Consequently 3D-tracking may not produce the desired results with subjects that are the same color as the background.

See Also

For information on the AF-area modes available in live view, see page 82.

Focus Point Selection

In manual focus mode or when autofocus is combined with AF-area modes other than **[]** (**Auto-area AF**), you can choose from 11 focus points, making it possible to compose photographs with the main subject almost anywhere in the frame.

- 1 Choose an AF-area mode other than **[]** (**Auto-area AF**; [□ 38](#)).



- 2 Select the focus point.



Use the multi selector to select the focus point in the viewfinder or information display while the exposure meters are on. Press **OK** to select the center focus point.

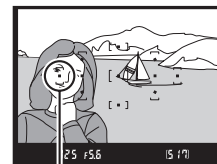

Focus Lock

Focus lock can be used to change the composition after focusing in **AF-A**, **AF-S**, and **AF-C** focus modes ([□ 35](#)), making it possible to focus on a subject that will not be in a focus point in the final composition. If the camera is unable to focus using autofocus ([□ 36](#)), focus lock can also be used to recompose the photograph after focusing on another object at the same distance as your original subject. Focus lock is most effective when an option other than **[]** (**Auto-area AF**) is selected for AF-area mode ([□ 38](#)).

- 1 Focus.

Position the subject in the selected focus point and press the shutter-release button halfway to initiate focus. Check that the in-focus indicator (●) appears in the viewfinder.



2 Lock focus.

AF-A and AF-C focus modes: With the shutter-release button pressed halfway (①), press the AE-L/AF-L (ⓘ) button (②) to lock both focus and exposure (an **AE-L** icon will be displayed in the viewfinder;  61). Focus will remain locked while the AE-L/AF-L (ⓘ) button is pressed, even if you later remove your finger from the shutter-release button.

Shutter-release button

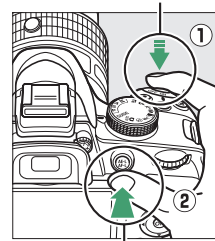

AE-L/AF-L (ⓘ) button



AF-S focus mode: Focus will lock automatically when the in-focus indicator appears, and remain locked until you remove your finger from the shutter-release button. Focus can also be locked by pressing the AE-L/AF-L (ⓘ) button (see above).



3 Recompose the photograph and shoot.

Focus will remain locked between shots if you keep the shutter-release button pressed halfway (**AF-S**) or keep the AE-L/AF-L (ⓘ) button pressed, allowing several photographs in succession to be taken at the same focus setting.

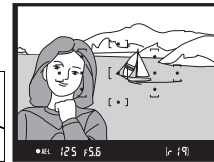

Do not change the distance between the camera and the subject while focus lock is in effect. If the subject moves, focus again at the new distance.

The AE-L/AF-L (ⓘ) Button

The **Buttons > Assign AE-L/AF-L button** option in the setup menu ( 143) controls the behavior of the AE-L/AF-L (ⓘ) button.

Manual Focus

Manual focus can be used when you are not using an AF-S or AF-I lens or when autofocus does not produce the desired results (□ 36).

1 Set the lens focus-mode switch.

If the lens is equipped with an A-M or M/A-M mode switch, slide the switch to **M**.

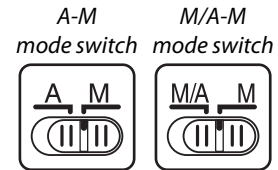

2 Focus.

To focus manually, adjust the lens focus ring until the image displayed on the clear matte field in the viewfinder is in focus. Photographs can be taken at any time, even when the image is not in focus.

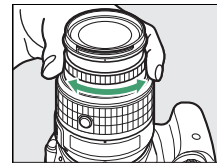

■ ■ The Electronic Rangefinder

If the lens has a maximum aperture of $f/5.6$ or faster, the viewfinder focus indicator can be used to confirm whether the subject in the selected focus point is in focus (the focus point can be selected from any of the 11 focus points). After positioning the subject in the selected focus point, press the shutter-release button halfway and rotate the lens focus ring until the in-focus indicator (●) is displayed. Note that with the subjects listed on page 36, the in-focus indicator may sometimes be displayed when the subject is not in focus; confirm focus in the viewfinder before shooting.

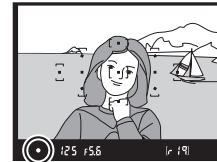

 **Selecting Manual Focus with the Camera**

If the lens supports M/A (autofocus with manual override), manual focus can also be selected by setting the camera focus mode to **MF** (manual focus;  35). Focus can then be adjusted manually, regardless of the mode selected with the lens.

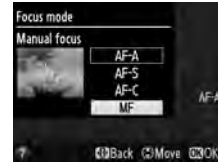

 **Focal Plane Position**

To determine the distance between your subject and the camera, measure from the focal plane mark on the camera body. The distance between the lens mounting flange and the focal plane is 46.5 mm (1.83 in.).

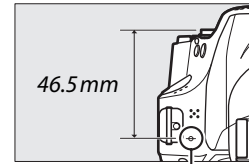

 **The Exposure Indicator**

If desired, the exposure indicator can be used to determine whether the focus point for manual focus is in front of or behind the subject ( 142).



Image Quality and Size

Together, image quality and size determine how much space each photograph occupies on the memory card. Larger, higher quality images can be printed at larger sizes but also require more memory, meaning that fewer such images can be stored on the memory card (☞ 188).

Image Quality

Choose a file format and compression ratio (image quality).



Option	File type	Description
NEF (RAW) + JPEG fine	NEF/JPEG	Two images are recorded: one NEF (RAW) image and one fine-quality JPEG image.
NEF (RAW)	NEF	Raw 12-bit data from the image sensor are saved directly to the memory card. Settings such as white balance and contrast can be adjusted after shooting.
JPEG fine	JPEG	Record JPEG images at a compression ratio of roughly 1 : 4 (fine quality).
JPEG normal		Record JPEG images at a compression ratio of roughly 1 : 8 (normal quality).
JPEG basic		Record JPEG images at a compression ratio of roughly 1 : 16 (basic quality).

1 Place the cursor in the information display.

If shooting information is not displayed in the monitor, press the button. Press the button again to place the cursor in the information display.

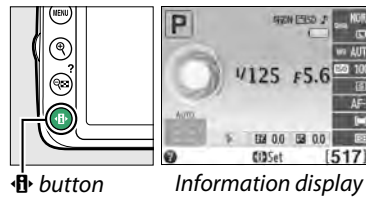

2 Display image quality options.

Highlight the current image quality in the information display and press .



3 Choose a file type.

Highlight an option and press . To return to shooting mode, press the shutter-release button halfway.



NEF (RAW) Images

Note that the option selected for image size does not affect the size of NEF (RAW) or NEF (RAW)+JPEG images. **Print date** (☐ 144) is not available at image quality settings of NEF (RAW) or NEF (RAW)+JPEG.

NEF (RAW) images can be viewed on the camera or using software such as Capture NX 2 (available separately; ☐ 176) or ViewNX 2 (available on the supplied ViewNX 2 CD). JPEG copies of NEF (RAW) images can be created using the **NEF (RAW) processing** option in the retouch menu (☐ 157).

NEF (RAW) + JPEG Fine

When photographs taken at **NEF (RAW) + JPEG fine** are viewed on the camera, only the JPEG image will be displayed. When photographs taken at these settings are deleted, both NEF and JPEG images will be deleted.

The Shooting Menu

Image quality can also be adjusted using the **Image quality** option in the shooting menu (☐ 127).





The Fn Button

Image quality and size can also be adjusted by pressing the **Fn** button and rotating the command dial (☐ 143).





Image Size

Image size is measured in pixels. Choose from the following options:

Image size	Size (pixels)	Print size (cm/in.)*
 Large	6,016 × 4,000	50.9 × 33.9/20.1 × 13.3
 Medium	4,512 × 3,000	38.2 × 25.4/15 × 10
 Small	3,008 × 2,000	25.5 × 16.9/10 × 6.7

* Approximate size when printed at 300 dpi. Print size in inches equals image size in pixels divided by printer resolution in dots per inch (dpi; 1 inch=approximately 2.54 cm).

1 Place the cursor in the information display.

If shooting information is not displayed in the monitor, press the  button. Press the  button again to place the cursor in the information display.

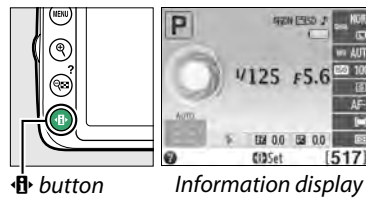

 button Information display

2 Display image size options.

Highlight the current image size in the information display and press .



3 Choose an image size.

Highlight an option and press . To return to shooting mode, press the shutter-release button halfway.



The Shooting Menu

Image size can also be adjusted using the **Image size** option in the shooting menu ( 127).



The Fn Button

Image quality and size can also be adjusted by pressing the **Fn** button and rotating the command dial ( 143).

Using the Built-in Flash

The camera supports a variety of flash modes for photographing poorly lit or backlit subjects.

■ ■ Using the Built-in Flash: , , , , and Modes

1 Choose a flash mode ( 48).

2 Take pictures.

The flash will pop up as required when the shutter-release button is pressed halfway, and fire when a photograph is taken. *If the flash does not pop up automatically, DO NOT attempt to raise it by hand. Failure to observe this precaution could damage the flash.*

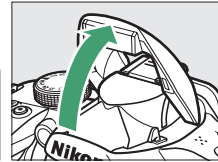

■ ■ Using the Built-in Flash: P, S, A, and M Modes

1 Raise the flash.



Press the  () button to raise the flash.

2 Choose a flash mode ( 48).

3 Take pictures.

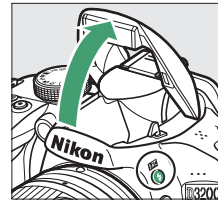
The flash will fire whenever a picture is taken.



 () button

Lowering the Built-in Flash

To save power when the flash is not in use, press it gently downward until the latch clicks into place.

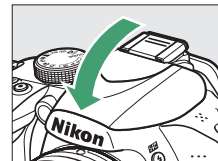

Flash Mode

The flash modes available vary with shooting mode:

AUTO, , , ,			
AUTO	Auto	AUTO SLOW	Auto slow sync + red-eye
AUTO	Auto + red-eye reduction	AUTO SLOW	Auto slow sync
	Flash off		Flash off
P, A		S, M	
	Fill flash		Fill flash
	Red-eye reduction		Red-eye reduction
SLOW	Slow sync + red-eye	REAR	Rear-curtain sync
SLOW	Slow sync		
REAR *	Rear-curtain + slow sync		



* SLOW appears in information display when setting is complete.

1 Place the cursor in the information display.

If shooting information is not displayed in the monitor, press the button. Press the button again to place the cursor in the information display.

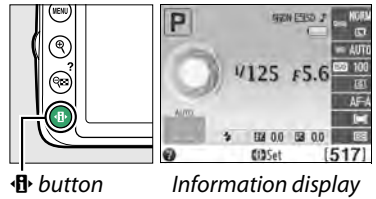

2 Display flash mode options.

Highlight the current flash mode in the information display and press .



3 Choose a flash mode.

Highlight a mode and press . To return to shooting mode, press the shutter-release button halfway.



Flash Modes

The flash modes listed on the previous page may combine one or more of the following settings, as shown by the flash mode icon:

- **AUTO (auto flash):** When lighting is poor or subject is back lit, flash pops up automatically when shutter-release button is pressed halfway and fires as required.
- **☉ (red-eye reduction):** Use for portraits. Red-eye reduction lamp lights before flash fires, reducing "red-eye."
- **⊕ (off):** Flash does not fire even when lighting is poor or subject is back-lit.
- **SLOW (slow sync):** Shutter speed slows automatically to capture background lighting at night or under low light. Use to include background lighting in portraits.
- **REAR (rear-curtain sync):** Flash fires just before shutter closes, creating a stream of light behind moving light sources (below at right). If this icon is not displayed, flash will fire as the shutter opens (front-curtain sync; the effect this produces with moving light sources is shown below at left).





Front-curtain sync



Rear-curtain sync

Choosing a Flash Mode

The flash mode can also be selected by pressing the  button and rotating the command dial (in P, S, A, and M modes, raise the flash before using the  button to choose the flash mode).

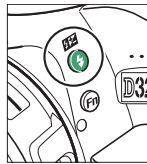

 button

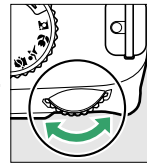

Command dial

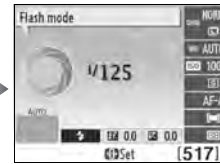

Information display

The Built-in Flash





For information on the lenses that can be used with the built-in flash, see page 170. Remove lens hoods to prevent shadows. The flash has a minimum range of 0.6 m (2 ft) and can not be used in the macro range of zoom lenses with a macro function.

The shutter release may be briefly disabled to protect the flash after it has been used for several consecutive shots. The flash can be used again after a short pause.



 **Shutter Speeds Available with the Built-in Flash**

Shutter speed is restricted to the following ranges when the built-in flash is used:

Mode	Shutter speed	Mode	Shutter speed
AUTO,  ,  ,  , P, A	$1/200$ – $1/60$ s	S	$1/200$ –30 s
	$1/200$ – $1/30$ s	M	$1/200$ –30 s, Bulb
	$1/200$ –1 s		

Shutter speeds as slow as 30 s are available in slow sync, rear curtain + slow sync, and slow sync + red-eye reduction modes.

 **Aperture, Sensitivity, and Flash Range**

Flash range varies with sensitivity (ISO equivalency) and aperture.

Aperture at ISO equivalent of							Approximate range	
100	200	400	800	1600	3200	6400	m	ft
1.4	2	2.8	4	5.6	8	11	1.0–8.5	3ft 3in.–27ft 11in.
2	2.8	4	5.6	8	11	16	0.7–6.0	2ft 4in.–19ft 8in.
2.8	4	5.6	8	11	16	22	0.6–4.2	2ft–13ft 9in.
4	5.6	8	11	16	22	32	0.6–3.0	2ft–9ft 10in.
5.6	8	11	16	22	32	—	0.6–2.1	2ft–6ft 11in.
8	11	16	22	32	—	—	0.6–1.5	2ft–4ft 11in.
11	16	22	32	—	—	—	0.6–1.1	2ft–3ft 7in.
16	22	32	—	—	—	—	0.6–0.7	2ft–2ft 4in.



ISO Sensitivity

“ISO sensitivity” is the digital equivalent of film speed. The higher the ISO sensitivity, the less light needed to make an exposure, allowing higher shutter speeds or smaller apertures, but the more likely the image is to be affected by noise (randomly-spaced bright pixels, fog, or lines; noise is particularly likely at a setting of Hi 1, which is equivalent to ISO 12800). Choosing **Auto** allows the camera to set ISO sensitivity automatically in response to lighting conditions.

Mode	ISO sensitivity
Auto,	Auto
P, S, A, M	100–6400 in steps of 1 EV; Hi 1
Other shooting modes	Auto; 100–6400 in steps of 1 EV; Hi 1

1 Place the cursor in the information display.

If shooting information is not displayed in the monitor, press the button. Press the button again to place the cursor in the information display.



button



Information display

2 Display ISO sensitivity options.

Highlight the current ISO sensitivity in the information display and press .



3 Choose an ISO sensitivity.

Highlight an option and press . To return to shooting mode, press the shutter-release button halfway.



AUTO

If the mode dial is rotated to **P**, **S**, **A**, or **M** after **Auto** is selected for ISO sensitivity in another mode, the ISO sensitivity last selected in **P**, **S**, **A**, or **M** mode will be restored. Note that if the ISO sensitivity selected by the user is higher than the value selected for the **ISO sensitivity settings > Auto ISO sensitivity control > Maximum sensitivity** option in the shooting menu, the value selected for **Maximum sensitivity** (📖 129) will be used instead.

The Shooting Menu

ISO sensitivity can also be adjusted using the **ISO sensitivity settings** option in the shooting menu (📖 127).

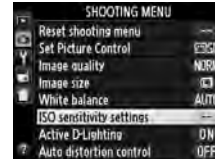

See Also

For information on enabling auto ISO sensitivity control in **P**, **S**, **A**, or **M** modes, see page 129. For information on using the **Noise reduction** option in the shooting menu to reduce noise at high ISO sensitivities, see page 131. For information on using the **Fn** button and the command dial to select ISO sensitivity, see page 143.





P, S, A, and M Modes

Shutter Speed and Aperture

P, S, A, and M modes offer different degrees of control over shutter speed and aperture:



Mode	Description
P Programmed auto (□ 54)	Camera sets shutter speed and aperture for optimal exposure. Recommended for snapshots and in other situations in which there is little time to adjust camera settings.
S Shutter-priority auto (□ 55)	User chooses shutter speed; camera selects aperture for best results. Use to freeze or blur motion.
A Aperture-priority auto (□ 56)	User chooses aperture; camera selects shutter speed for best results. Use to blur background or bring both foreground and background into focus.
M Manual (□ 57)	User controls both shutter speed and aperture. Set shutter speed to "Bulb" or "Time" for long time-exposures.

✓ Lens Aperture Rings

When using a CPU lens equipped with an aperture ring (□ 168), lock the aperture ring at the minimum aperture (highest f-number). Type G lenses are not equipped with an aperture ring.

✓ Shutter Speed and Aperture

The same exposure can be achieved with different combinations of shutter speed and aperture. Fast shutter speeds and large apertures freeze moving objects and soften background details, while slow shutter speeds and small apertures blur moving objects and bring out background details.

Shutter speed ——— Aperture



Fast shutter speed
(1/1,600 s)



Slow shutter speed
(1 s)



Large aperture (f/5.6)



Small aperture (f/22)

(Remember, the higher the f-number, the smaller the aperture.)

Mode P (Programmed Auto)

In this mode, the camera automatically adjusts shutter speed and aperture for optimal exposure in most situations. This mode is recommended for snapshots and other situations in which you want to leave the camera in charge of shutter speed and aperture. To take photographs in programmed auto:

- 1 Rotate the mode dial to P.

Mode dial

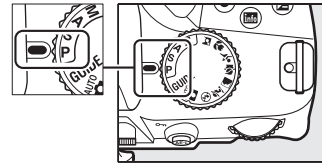

- 2 Frame a photograph, focus, and shoot.



Flexible Program

In mode P, different combinations of shutter speed and aperture can be selected by rotating the command dial (“flexible program”). Rotate the dial to the right for large apertures (low f-numbers) that blur background details or fast shutter speeds that “freeze” motion. Rotate the dial to the left for small apertures (high f-numbers) that increase depth of field or slow shutter speeds that blur motion. All combinations produce the same exposure. While flexible program is in effect, a  (P₁) indicator appears in the viewfinder and information display. To restore default shutter speed and aperture settings, rotate the command dial until the indicator is no longer displayed, choose another mode, or turn the camera off.

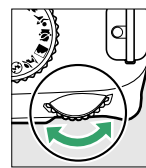

Command dial

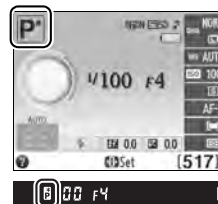

Mode S (Shutter-Priority Auto)

In shutter-priority auto, you choose the shutter speed while the camera automatically selects the aperture that will produce the optimal exposure. Use slow shutter speeds to suggest motion by blurring moving subjects, fast shutter speeds to “freeze” motion.



Fast shutter speed ($1/1,600$ s)



Slow shutter speed (1 s)

To take photographs in shutter-priority auto:

- 1 Rotate the mode dial to S.

Mode dial

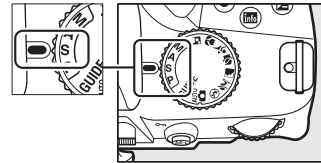

- 2 Choose a shutter speed.

Shutter speed is shown in the viewfinder and information display. Rotate the command dial to choose the desired shutter speed from values between 30 s and $1/4,000$ s.

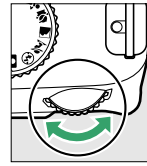

Command dial



- 3 Frame a photograph, focus, and shoot.

Mode A (Aperture-Priority Auto)

In aperture-priority auto, you choose the aperture while the camera automatically selects the shutter speed that will produce the optimal exposure. Large apertures (low f-numbers) reduce depth of field, blurring objects behind and in front of the main subject. Small apertures (high f-numbers) increase depth of field, bringing out details in the background and foreground. Short field depths are generally used in portraits to blur background details, long field depths in landscape photographs to bring the foreground and background into focus.



Large aperture (f/5.6)



Small aperture (f/22)



To take photographs in aperture-priority auto:

1 Rotate the mode dial to A.

Mode dial

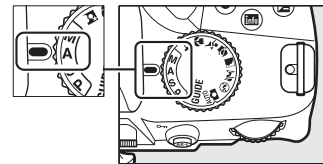

2 Choose an aperture.

Aperture is shown in the viewfinder and information display. Rotate the command dial to choose the desired aperture from values between the minimum and maximum for the lens.

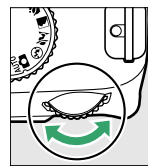

Command dial



3 Frame a photograph, focus, and shoot.

Mode M (Manual)

In manual exposure mode, you control both shutter speed and aperture. To take photographs in manual exposure mode:

1 Rotate the mode dial to M.

Mode dial

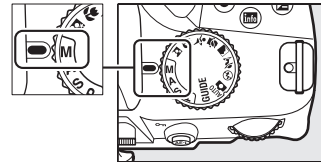

2 Choose aperture and shutter speed.

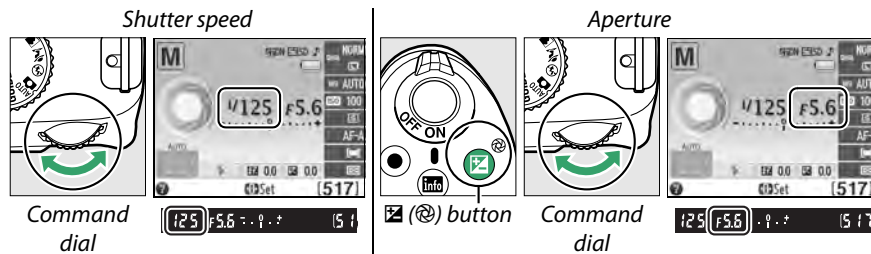

Checking the exposure indicator (see below), adjust shutter speed and aperture. Shutter speed is selected by rotating the command dial: choose from values between 30 s and $1/4,000$ s or select “Bulb” or “Time” to hold the shutter open indefinitely for a long time-exposure (□ 58). Aperture is selected by pressing the  button and rotating the command dial: choose from values between the minimum and maximum for the lens. Shutter speed and aperture are shown in the viewfinder and information display.



3 Frame a photograph, focus, and shoot.

The Exposure Indicator

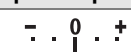
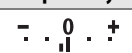
If a CPU lens is attached and a shutter speed other than “Bulb” or “Time” is selected, the exposure indicator in the viewfinder and information display shows whether the photograph would be under- or over-exposed at current settings (the illustrations below show the display in the viewfinder). The displays will flash if the limits of the exposure metering system are exceeded.

Optimal exposure	Underexposed by $1/3$ EV	Overexposed by over 2 EV
		

■ ■ Long Time-Exposures (M Mode Only)

Select the following shutter speeds for long time-exposures of moving lights, the stars, night scenery, or fireworks.

- **Bulb (b u l b):** The shutter remains open while the shutter-release button is held down. To prevent blur, use a tripod or an optional MC-DC2 remote cord (□ 177).
- **Time (- -):** Requires an optional ML-L3 remote control (□ 177). Start the exposure by pressing the ML-L3 shutter-release button. The shutter remains open for thirty minutes or until the button is pressed a second time.



Length of exposure: 35 s
Aperture: f/25

1 Ready the camera.



Mount the camera on a tripod or place it on a stable, level surface. To prevent light entering via the viewfinder interfering with exposure, remove the rubber eyecup and cover the viewfinder with the supplied DK-5 eyepiece cap (□ 34). To prevent loss of power before the exposure is complete, use a fully charged EN-EL14 battery or an optional EH-5b AC adapter and EP-5A power connector. Note that noise (bright spots, randomly-spaced bright pixels, or fog) may be present in long exposures; before shooting, choose **On** for **Noise reduction** in the shooting menu (□ 131).

2 Rotate the mode dial to M.

Mode dial

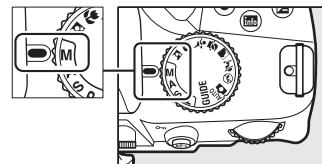

3 Choose a shutter speed.

Rotate the command dial to choose a shutter speed of Bulb (b u l b). For a shutter speed of "Time" (- -), select a remote control release mode (□ 33) after choosing the shutter speed.

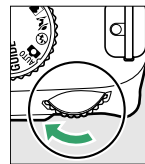

Command dial

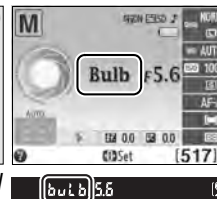

4 Open the shutter.

Bulb: After focusing, press the shutter-release button on the camera or optional remote cord all the way down. Keep the shutter-release button pressed until the exposure is complete.

Time: Press the ML-L3 shutter-release button all the way down.

5 Close the shutter.

Bulb: Take your finger off the shutter-release button.





Time: Press the ML-L3 shutter-release button all the way down. Shooting ends automatically after thirty minutes.





Exposure

Metering

Choose how the camera sets exposure in **P**, **S**, **A**, and **M** modes (in other modes, the camera selects the metering method automatically).

Method	Description
 Matrix metering	Produces natural results in most situations. Camera uses 420-pixel RGB sensor to meter a wide area of the frame and set exposure according to tone distribution, color, composition, and, with type G or D lenses (□ 168), distance information (3D color matrix metering II; with other CPU lenses, the camera uses color matrix metering II, which does not include 3D distance information).
 Center-weighted metering	Camera meters entire frame but assigns greatest weight to center area. Classic meter for portraits; recommended when using filters with an exposure factor (filter factor) over 1x.
  Spot metering	Camera meters current focus point; use to meter off-center subjects (if  Auto-area AF is selected for AF-area mode during viewfinder photography as described on page 38, camera will meter center focus point). Ensures that subject will be correctly exposed, even when background is much brighter or darker.

1 Place the cursor in the information display.

If shooting information is not displayed in the monitor, press the  button. Press the  button again to place the cursor in the information display.

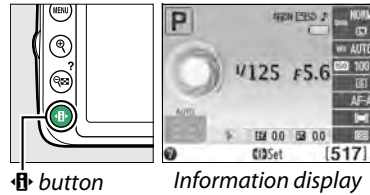

 button

Information display

2 Display metering options.

Highlight the current metering method in the information display and press .







3 Choose a metering method.

Highlight an option and press . To return to shooting mode, press the shutter-release button halfway.



Autoexposure Lock

Use autoexposure lock to recompose photographs after using  (**Center-weighted metering**) and  (**Spot metering**) to meter exposure; note that autoexposure lock is not available in  or  mode.

1 Meter exposure.

Position the subject in the center of the frame (center-weighted metering) or the selected focus point (spot metering) and press the shutter-release button halfway to set focus and meter exposure. Check that the in-focus indicator (●) appears in the viewfinder.

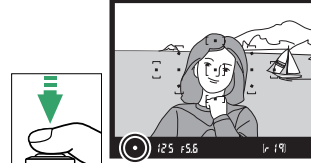

2 Lock exposure.

With the shutter-release button pressed halfway (①) and the subject positioned in the focus point, press the  (●) button (②) to lock exposure.

Autoexposure Lock

If **On** is selected for **Buttons > Shutter-release button AE-L** in the setup menu (□ 144), exposure will lock when the shutter-release button is pressed halfway. For information on changing the role of the  button, see **Buttons > Assign AE-L/AF-L button**.

While exposure lock is in effect, an **AE-L** indicator will appear in the viewfinder.

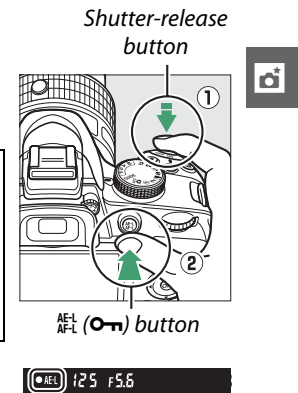

3 Recompose the photograph.

Keeping the  button pressed, recompose the photograph and shoot.

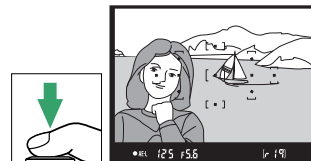

The Shooting Menu

Metering can also be adjusted using the **Metering** option in the shooting menu (☰ 127).

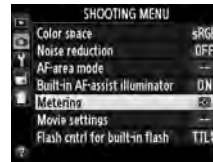

Adjusting Shutter Speed and Aperture



While exposure lock is in effect, the following settings can be adjusted without altering the metered value for exposure:

Mode	Setting
Programmed auto	Shutter speed and aperture (flexible program; ☰ 54)
Shutter-priority auto	Shutter speed
Aperture-priority auto	Aperture

The metering method itself can not be changed while exposure lock is in effect.



Exposure Compensation

Exposure compensation is used to alter exposure from the value suggested by the camera, making pictures brighter or darker. It is most effective when used with  (**Center-weighted metering**) or  (**Spot metering**) (book 60). Choose from values between -5 EV (underexposure) and $+5$ EV (overexposure) in increments of $1/3$ EV. In general, positive values make the subject brighter while negative values make it darker.



-1 EV





No exposure compensation





+1 EV

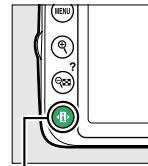

1 Place the cursor in the information display.

If shooting information is not displayed in the monitor, press the  button. Press the  button again to place the cursor in the information display.



 button



Information display

2 Display exposure compensation options.

Highlight exposure compensation in the information display and press .



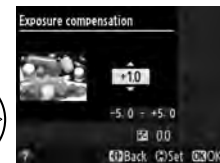

3 Choose a value.

Highlight a value and press . To return to shooting mode, press the shutter-release button halfway.



Normal exposure can be restored by setting exposure compensation to ± 0 . Exposure compensation is not reset when the camera is turned off.

 **The  Button**

Exposure compensation can also be set by pressing the  button and rotating the command dial. The selected value is shown in the viewfinder and information display.

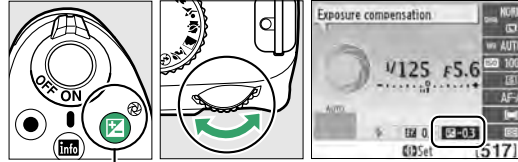

 button Command dial



 **Mode M**

In mode **M**, exposure compensation affects only the exposure indicator; shutter speed and aperture do not change.

 **Using a Flash**



When a flash is used, exposure compensation affects both background exposure and flash level.



Flash Compensation

Flash compensation is used to alter flash output from the level suggested by the camera, changing the brightness of the main subject relative to the background. Choose from values between -3 EV (darker) and $+1$ EV (brighter) in increments of $\frac{1}{3}$ EV; in general, positive values make the subject brighter while negative values make it darker.

1 Place the cursor in the information display.

If shooting information is not displayed in the monitor, press the  button. Press the  button again to place the cursor in the information display.

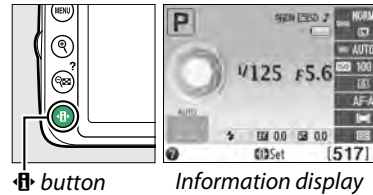

2 Display flash compensation options.

Highlight flash compensation in the information display and press .





3 Choose a value.

Highlight a value and press . To return to shooting mode, press the shutter-release button halfway.



Normal flash output can be restored by setting flash compensation to ± 0 . Flash compensation is not reset when the camera is turned off.

The  (BZ) and  (Ⓢ) Buttons

Flash compensation can also be set by rotating the command dial while pressing the  (BZ) and  (Ⓢ) buttons. The selected value is shown in the viewfinder and information display.

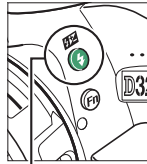

 (BZ) button

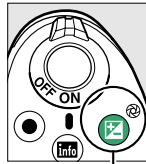

 (Ⓢ) button

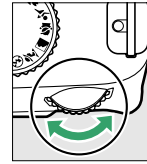

Command dial



Optional Flash Units

Flash compensation is also available with optional flash units that support the Nikon Creative Lighting System (CLS; see page 173). The SB-910, SB-900, SB-800, SB-700, and SB-600 also allow flash compensation to be set using the controls on the flash unit. The flash compensation selected with the optional flash unit is added to the flash compensation selected with the camera.



Preserving Detail in Highlights and Shadows

Active D-Lighting

When **On** is selected, the camera automatically adjusts Active D-Lighting during shooting to preserve details in highlights and shadows, creating photographs with natural contrast. Use for high contrast scenes, for example when photographing brightly lit outdoor scenery through a door or window or taking pictures of shaded subjects on a sunny day. It is most effective when used with  **Matrix metering** (📖 60).



Active D-Lighting: **Off**



Active D-Lighting: **On**



- 1 Display Active D-Lighting options.**
Press the **MENU** button to display the menus. Highlight **Active D-Lighting** in the shooting menu and press **▶**.



MENU button

- 2 Choose an option.**
Highlight **On** or **Off** and press **OK**. To return to shooting mode, press the shutter-release button halfway.



✓ **Active D-Lighting**

Noise (randomly-spaced bright pixels, fog, or lines) may appear in photographs taken with Active D-Lighting. Uneven shading may be visible with some subjects. Active D-Lighting can not be used at an ISO sensitivity of Hi 1.

✓ **“Active D-Lighting” Versus “D-Lighting”**

The **Active D-Lighting** option in the shooting menu adjusts exposure before shooting to optimize the dynamic range, while the **D-Lighting** option in the retouch menu (📖 151) optimizes dynamic range in images after shooting.







✓ **See Also**

For information on using the **Fn** button and command dial to turn Active D-Lighting on and off, see page 143.





White Balance

White balance ensures that colors are unaffected by the color of the light source. Auto white balance is recommended for most light sources; in **P**, **S**, **A**, and **M** modes, other values can be selected if necessary according to the type of source:

Option	Description
AUTO Auto	Automatic white balance adjustment. Recommended in most situations.
 Incandescent	Use under incandescent lighting.
 Fluorescent	Use with the light sources listed on page 70.
 Direct sunlight	Use with subjects lit by direct sunlight.
 Flash	Use with the flash.
 Cloudy	Use in daylight under overcast skies.
 Shade	Use in daylight with subjects in the shade.
PRE Preset manual	Measure white balance or copy white balance from existing photo (p. 72).

1 Place the cursor in the information display.

If shooting information is not displayed in the monitor, press the  button. Press the  button again to place the cursor in the information display.

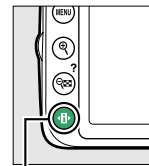

 button



Information display

2 Display white balance options.

Highlight the current white balance setting in the information display and press .



3 Choose a white balance option.

Highlight an option and press . To return to shooting mode, press the shutter-release button halfway.



The Shooting Menu

White balance can be selected using the **White balance** option in the shooting menu (📖 127), which also can be used to fine-tune white balance (📖 71) or measure a value for preset white balance (📖 72).





The  **Fluorescent** option in the **White balance** menu can be used to select the light source from the bulb types shown at right.



Color Temperature

The perceived color of a light source varies with the viewer and other conditions. Color temperature is an objective measure of the color of a light source, defined with reference to the temperature to which an object would have to be heated to radiate light in the same wavelengths. While light sources with a color temperature in the neighborhood of 5,000–5,500 K appear white, light sources with a lower color temperature, such as incandescent light bulbs, appear slightly yellow or red. Light sources with a higher color temperature appear tinged with blue. The camera white balance options are adapted to the following color temperatures:

-  (sodium-vapor lamps): **2,700 K**
-  (incandescent)/
•  (warm-white fluorescent): **3,000 K**
-  (white fluorescent): **3,700 K**
-  (cool-white fluorescent): **4,200 K**
-  (day white fluorescent): **5,000 K**
-  (direct sunlight): **5,200 K**
-  (flash): **5,400 K**
-  (cloudy): **6,000 K**
-  (daylight fluorescent): **6,500 K**
-  (high temp. mercury-vapor): **7,200 K**
-  (shade): **8,000 K**

The Fn Button

For information on using the **Fn** button and the command dial to select a white balance option, see page 143.



Fine-Tuning White Balance

White balance can be “fine-tuned” to compensate for variations in the color of the light source or to introduce a deliberate color cast into an image. White balance is fine-tuned using the **White balance** option in the shooting menu.

1 Display white balance options.

To display the menus, press the **MENU** button. Highlight **White balance** in the shooting menu and press **▶** to display white balance options.



MENU button

2 Select a white balance option.

Highlight an option other than **Preset manual** and press **▶** (if **Fluorescent** is selected, highlight a lighting type and press **▶**). The fine-tuning options shown at right will be displayed. Fine-tuning is not available with **Preset manual** white balance.

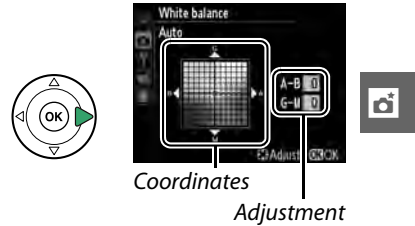

3 Fine-tune white balance.

Use the multi selector to fine-tune white balance.

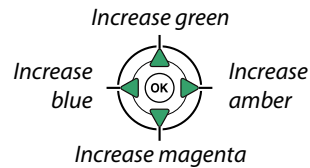

White Balance Fine-Tuning

The colors on the fine-tuning axes are relative, not absolute. For example, moving the cursor to **B** (blue) when a “warm” setting such as  (incandescent) is selected will make photographs slightly “colder” but will not actually make them blue.

4 Save changes and exit.

Press **OK**.



Preset Manual

Preset manual is used to record and recall custom white balance settings for shooting under mixed lighting or to compensate for light sources with a strong color cast. Two methods are available for setting preset white balance:

Method	Description
Measure	Neutral gray or white object is placed under lighting that will be used in final photo and white balance measured by camera (see below).
Use photo	White balance is copied from photo on memory card (☞ 75).

■ ■ Measuring a Value for Preset White Balance

1 Light a reference object.

Place a neutral gray or white object under the lighting that will be used in the final photograph.



2 Display white balance options.

To display the menus, press the MENU button. Highlight **White balance** in the shooting menu and press ► to display white balance options. Highlight **Preset manual** and press ►.

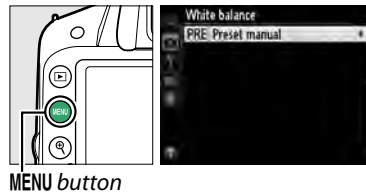

MENU button

3 Select Measure.

Highlight **Measure** and press ►. The menu shown at right will be displayed; highlight **Yes** and press OK.



The message shown at right will be displayed before the camera enters preset measurement mode.

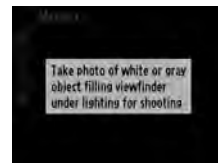

When the camera is ready to measure white balance, a flashing **P_{RE}** will appear in the viewfinder and information display.

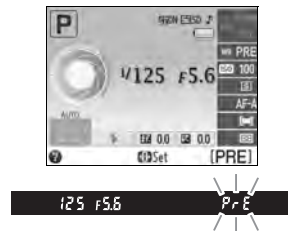

4 Measure white balance.

Before the indicators stop flashing, frame the reference object so that it fills the viewfinder and press the shutter-release button all the way down. No photograph will be recorded; white balance can be measured accurately even when the camera is not in focus.



5 Check the results.

If the camera was able to measure a value for white balance, the message shown at right will be displayed and **Wd** will flash in the viewfinder for about eight seconds before the camera returns to shooting mode. To return to shooting mode immediately, press the shutter-release button halfway.

If lighting is too dark or too bright, the camera may be unable to measure white balance. A message will appear in the information display and a flashing **no Wd** will appear in the viewfinder for about eight seconds. Return to Step 4 and measure white balance again.

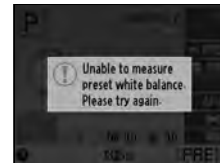
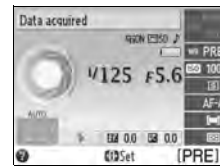

 **Measuring Preset White Balance**

If no operations are performed while the displays are flashing, direct measurement mode will end in the time selected for the **Auto off timers** option in the setup menu (☰ 140). The default setting is eight seconds.

 **Preset White Balance**

The camera can store only one value for preset white balance at a time; the existing value will be replaced when a new value is measured. Note that exposure is automatically increased by 1 EV when measuring white balance; when shooting in mode **M**, adjust exposure so that the exposure indicator shows ± 0 (☰ 57).

 **Other Methods for Measuring Preset White Balance**

To enter preset measurement mode (see above) after selecting preset white balance in the information display (☰ 69), press  for a few seconds. If white balance has been assigned to the **Fn** button (☰ 143) and preset white balance selected by pressing the **Fn** button and rotating the command dial, the camera will also enter preset measurement mode if the **Fn** button is pressed for a few seconds.

 **Studio Settings**

In studio settings, a standard gray panel can be used as a reference object when measuring preset white balance.



■ Copying White Balance from a Photograph

Follow the steps below to copy a value for white balance from a photograph on the memory card.

1 Select Preset manual.

To display the menus, press the MENU button. Highlight **White balance** in the shooting menu and press ► to display white balance options. Highlight **Preset manual** and press ►.



MENU button

2 Select Use photo.

Highlight **Use photo** and press ►.



3 Choose Select image.

Highlight **Select image** and press ► (to skip the remaining steps and use the image last selected for preset white balance, select **This image**).



4 Choose a folder.

Highlight the folder containing the source image and press ►.



5 Highlight the source image.

To view the highlighted image full frame, press and hold the Q button.



6 Copy white balance.

Press OK to set preset white balance to the white balance value for the highlighted photograph.









Picture Controls

Nikon's unique Picture Control system makes it possible to share image processing settings, including sharpening, contrast, brightness, saturation, and hue, among compatible devices and software.

Selecting a Picture Control

The camera offers six Picture Controls. In **P**, **S**, **A**, and **M** modes, you can choose a Picture Control according to the subject or type of scene (in other modes, the camera selects a Picture Control automatically).

Option	Description
 SD Standard	Standard processing for balanced results. Recommended for most situations.
 NL Neutral	Minimal processing for natural results. Choose for photographs that will later be extensively processed or retouched.
 VI Vivid	Pictures are enhanced for a vivid, photoprint effect. Choose for photographs that emphasize primary colors.
 MC Monochrome	Take monochrome photographs.
 PT Portrait	Process portraits for skin with natural texture and a rounded feel.
 LS Landscape	Produces vibrant landscapes and cityscapes.

1 Display Picture Controls.

To display the menus, press the **MENU** button. Highlight **Set Picture Control** in the shooting menu and press **▶** to display a list of Picture Controls.

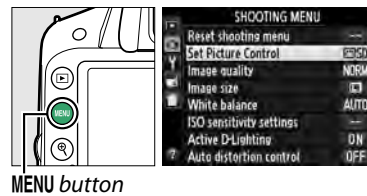

2 Choose a Picture Control.

Highlight an option and press **OK**.



Modifying Picture Controls

Picture Controls can be modified to suit the scene or the user's creative intent. Choose a balanced combination of settings using **Quick adjust**, or make manual adjustments to individual settings.

1 Display the Picture Control menu.

To display the menus, press the **MENU** button. Highlight **Set Picture Control** in the shooting menu and press **▶**.



MENU button

2 Select a Picture Control.

Highlight the desired Picture Control and press **▶**.



3 Adjust settings.

Press **▲** or **▼** to highlight the desired setting and press **◀** or **▶** to choose a value (78). Repeat this step until all settings have been adjusted, or select **Quick adjust** to choose a preset combination of settings. Default settings can be restored by pressing the **Reset** button.



4 Save changes and exit.

Press **OK**.





✍ Modifications to Original Picture Controls

Picture Controls that have been modified from default settings are indicated by an asterisk (*).



Picture Control Settings

Option	Description
Quick adjust	Choose from options between -2 and +2 to reduce or exaggerate the effect of the selected Picture Control (note that this resets all manual adjustments). For example, choosing positive values for Vivid makes pictures more vivid. Not available with Neutral or Monochrome Picture Controls.
 Manual adjustments (all Picture Controls)	Sharpening Control the sharpness of outlines. Select A to adjust sharpening automatically according to the type of scene, or choose from values between 0 (no sharpening) and 9 (the higher the value, the greater the sharpening).
	Contrast Select A to adjust contrast automatically according to the type of scene, or choose from values between -3 and +3 (choose lower values to prevent highlights in portrait subjects from being “washed out” in direct sunlight, higher values to preserve detail in misty landscapes and other low-contrast subjects).
	Brightness Choose -1 for reduced brightness, +1 for enhanced brightness. Does not affect exposure.
 Manual adjustments (non-monochrome only)	Saturation Control the vividness of colors. Select A to adjust saturation automatically according to the type of scene, or choose from values between -3 and +3 (lower values reduce saturation and higher values increase it).
	Hue Choose negative values (to a minimum of -3) to make reds more purple, blues more green, and greens more yellow, positive values (up to +3) to make reds more orange, greens more blue, and blues more purple.
 Manual adjustments (monochrome only)	Filter effects Simulate the effect of color filters on monochrome photographs. Choose from Off , yellow, orange, red, and green (☞ 79).
	Toning Choose the tint used in monochrome photographs from B&W (black-and-white), Sepia , Cyanotype (blue-tinted monochrome), Red , Yellow , Green , Blue Green , Blue , Purple Blue , Red Purple (☞ 79).

✓ “A” (Auto)

Results for auto sharpening, contrast, and saturation vary with exposure and the position of the subject in the frame.

The Picture Control Grid

Pressing the **Q** button in Step 3 displays a Picture Control grid showing the contrast and saturation for the selected Picture Control in relation to the other Picture Controls (only contrast is displayed when **Monochrome** is selected). Release the **Q** button to return to the Picture Control menu.



The icons for Picture Controls that use auto contrast and saturation are displayed in green in the Picture Control grid, and lines appear parallel to the axes of the grid.

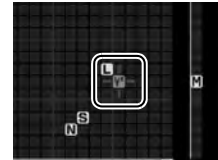

Previous Settings

The line under the value display in the Picture Control setting menu indicates the previous value for the setting. Use this as a reference when adjusting settings.

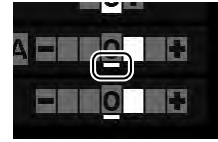

Filter Effects (Monochrome Only)

The options in this menu simulate the effect of color filters on monochrome photographs. The following filter effects are available:

Option	Description
Y Yellow	Enhances contrast. Can be used to tone down the brightness of the sky in landscape photographs. Orange produces more contrast than yellow, red more contrast than orange.
O Orange	
R Red	
G Green	Softens skin tones. Can be used for portraits.

Note that the effects achieved with **Filter effects** are more pronounced than those produced by physical glass filters.

Toning (Monochrome Only)

Pressing **▼** when **Toning** is selected displays saturation options. Press **◀** or **▶** to adjust saturation. Saturation control is not available when **B&W** (black-and-white) is selected.



Live View

Framing Photographs in the Monitor

Follow the steps below to take photographs in live view.

1 Press the **Lv** button.

The mirror will be raised and the view through the lens will be displayed in the camera monitor. The subject will no longer be visible in the viewfinder.

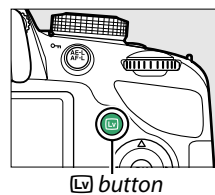

2 Position the focus point.

Position the focus point over your subject as described on page 83.



3 Focus.

Press the shutter-release button halfway. The focus point will flash green while the camera focuses. If the camera is able to focus, the focus point will be displayed in green; if the camera is unable to focus, the focus point will flash red (note that pictures can be taken even when the focus point flashes red; check focus in the monitor before shooting). Except in **AUTO** and **AF-L** modes, exposure can be locked by pressing the **AE-L/AF-L (O-m)** button.



4 Take the picture.

Press the shutter-release button the rest of the way down. The monitor turns off and the memory card access lamp lights during recording. *Do not remove the battery or memory card or unplug the optional AC adapter until recording is complete.* When shooting is complete, the photograph will be displayed in the monitor for a few seconds or until the shutter-release button is pressed halfway. The camera will then return to live view mode. To exit, press the **Lv** button.

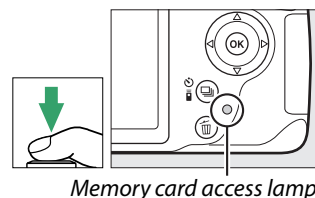

Focusing in Live View

Follow the steps below to choose focus and AF-area modes and position the focus point.

■ Choosing a Focus Mode

The following focus modes are available in live view:

Option	Description
AF-S Single-servo AF	For stationary subjects. Focus locks when shutter-release button is pressed halfway.
AF-F Full-time-servo AF	For moving subjects. Camera focuses continuously until shutter-release button is pressed halfway. Focus locks when shutter-release button is pressed halfway.
MF Manual focus	Focus manually (□ 42).

1 Place the cursor in the information display.

Press the  button to place the cursor in the information display.

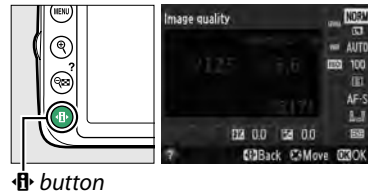



 button

2 Display focus options.

Highlight the current focus mode in the information display and press .









3 Choose a focus option.

Highlight an option and press . To return to live view, press .



■ ■ Choosing an AF-Area Mode

In modes other than  and , the following AF-area modes can be selected in live view:

Option	Description
 Face-priority AF	The camera automatically detects and focuses on portrait subjects. Use for portraits.
 Wide-area AF	Use for hand-held shots of landscapes and other non-portrait subjects. Use the multi selector to select the focus point.
 Normal-area AF	Use for pin-point focus on a selected spot in the frame. A tripod is recommended.
 Subject-tracking AF	Track a selected subject as it moves through the frame.

1 Place the cursor in the information display.

Press the  button to place the cursor in the information display.

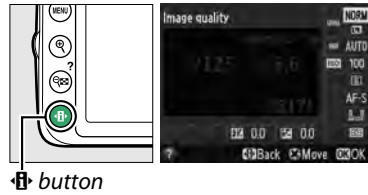



 button

2 Display AF-area modes.

Highlight the current AF-area mode in the information display and press .



3 Choose an AF-area mode.

Highlight an option and press . To return to live view, press .



■ ■ Choosing the Focus Point

The method for selecting the focus point for autofocus varies with the option selected for AF-area mode (82).

☺ (face-priority AF): A double yellow border will be displayed when the camera detects a portrait subject (if multiple faces, up to a maximum of 35, are detected, the camera will focus on the closest subject; to choose a different subject, use the multi selector). If the camera can no longer detect the subject (because, for example, the subject has turned to face away from the camera), the border will no longer be displayed.

☒ (wide- and normal-area AF): Use the multi selector to move the focus point anywhere in the frame, or press **OK** to position the focus point in the center of the frame.

☑ (subject-tracking AF): Position the focus point over your subject and press **OK**. The focus point will track the selected subject as it moves through the frame. To end focus tracking, press **OK** a second time.



Focus point



Focus point



Focus point

✓ Subject Tracking

The camera may be unable to track subjects if they move quickly, leave the frame or are obscured by other objects, change visibly in size, color, or brightness, or are too small, too large, too bright, too dark, or similar in color or brightness to the background.

■ The Live View Display

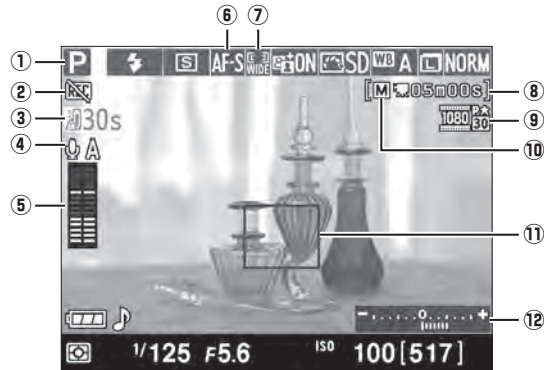

Item	Description	
① Shooting mode	The mode currently selected with the mode dial.	22, 25, 53
② “No movie” icon	Indicates that movies can not be recorded.	88
③ Time remaining	The amount of time remaining before live view ends automatically. Displayed if shooting will end in 30 s or less.	86, 91
④ Microphone sensitivity	Microphone sensitivity for movie recording.	90
⑤ Sound level	Sound level for audio recording. Displayed in red if level is too high; adjust microphone sensitivity accordingly. Left (L) and right (R) channel indicators appear when optional ME-1 or other stereo microphone is used.	90
⑥ Focus mode	The current focus mode.	81
⑦ AF-area mode	The current AF-area mode.	82
⑧ Time remaining (movie mode)	The recording time remaining in movie mode.	88
⑨ Movie frame size	The frame size of movies recorded in movie mode.	90
⑩ Manual movie settings indicator	Displayed when On is selected for Manual movie settings in mode M .	91
⑪ Focus point	The current focus point. The display varies with the option selected for AF-area mode (82).	83
⑫ Exposure indicator	Indicates whether the photograph would be under- or over-exposed at current settings (mode M only).	57



Live View/Movie Recording Display Options

Press the **Info** button to cycle through display options as shown below.

Circled areas indicate edges of movie frame crop

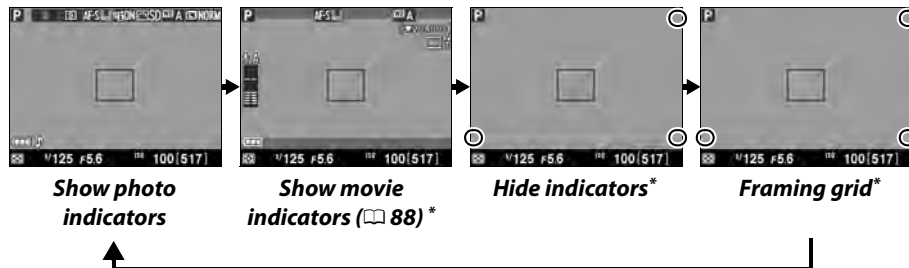

* A crop showing the area recorded is displayed during movie recording when frame sizes other than 640 × 424 are selected for **Movie settings > Frame size/frame rate** in the shooting menu (89; the area outside the movie frame crop is grayed out when movie indicators are displayed).

Automatic Scene Selection (Scene Auto Selector)

If live view is selected in **Auto** or **Scene** mode, the camera will automatically analyze the subject and select the appropriate shooting mode when autofocus is enabled. The selected mode is shown in the monitor (84).

	Portrait	Human portrait subjects
	Landscape	Landscapes and cityscapes
	Close up	Subjects close to the camera
	Night portrait	Portrait subjects framed against a dark background
	Auto	Subjects suited to Auto or Scene mode or that do not fall into the categories listed above
	Auto (flash off)	

Exposure

Depending on the scene, exposure may differ from that which would be obtained when live view is not used. Metering in live view is adjusted to suit the live view display, producing photographs with exposure close to what is seen in the monitor. In **P**, **S** and **A** modes, exposure can be adjusted by ±5 EV in increments of 1/3 EV (63). Note that the effects of values over +3 EV or under -3 EV can not be previewed in the monitor.



HDMI

When the camera is attached to an HDMI video device, the camera monitor will remain on and the video device will display the view through the lens as shown at right. If the device supports HDMI-CEC, select **Off** for the **HDMI > Device control** option in the setup menu (☞ 124) before shooting in live view.



Shooting in Live View Mode

To prevent light entering via the viewfinder from interfering with exposure, remove the rubber eyecup and cover the viewfinder with the supplied DK-5 eyepiece cap before shooting (☞ 34).

Although they will not appear in the final picture, distortion may be visible in the monitor if the camera is panned horizontally or an object moves at high speed through frame. Bright light sources may leave after-images in the monitor when the camera is panned. Bright spots may also appear. Flicker and banding visible in the monitor under fluorescent, mercury vapor, or sodium lamps can be reduced using **Flicker reduction** (☞ 136), although they may still be visible in the final photograph at some shutter speeds. When shooting in live view mode, avoid pointing the camera at the sun or other strong light sources. Failure to observe this precaution could result in damage to the camera's internal circuitry.

Live view ends automatically if the lens is removed, the mode dial is rotated to **GUIDE**, or the mode dial is rotated from **GUIDE** to another setting.

Live view may end automatically to prevent damage to the camera's internal circuits; exit live view when the camera is not in use. Note that the temperature of the camera's internal circuits may rise and noise (bright spots, randomly-spaced bright pixels, or fog) may be displayed in the following instances (the camera may also become noticeably warm, but this does not indicate a malfunction):

- The ambient temperature is high
- The camera has been used for extended periods in live view or to record movies
- The camera has been used in continuous release mode for extended periods

If live view does not start when you press the  button, wait for the internal circuits to cool and then try again.

The Count Down Display

A count down will be displayed 30 s before live view ends automatically (☞ 84; the timer turns red 5 s before the auto off timer expires (☞ 140) or if live view is about to end to protect the internal circuits). Depending on shooting conditions, the timer may appear immediately when live view is selected. Note that although the count down does not appear in the information display or during playback, live view will still end automatically when the timer expires.



✔ **Using Autofocus in Live View**

Autofocus is slower in live view and the monitor may brighten or darken while the camera focuses. The camera may be unable to focus in the following situations:





- The subject contains lines parallel to the long edge of the frame
- The subject lacks contrast
- The subject in the focus point contains areas of sharply contrasting brightness, or the subject is lit by spot lighting or by a neon sign or other light source that changes in brightness
- Flicker or banding appears under fluorescent, mercury-vapor, sodium-vapor, or similar lighting
- A cross (star) filter or other special filter is used
- The subject appears smaller than the focus point
- The subject is dominated by regular geometric patterns (e.g., blinds or a row of windows in a skyscraper)
- The subject is moving

Note that the focus point may sometimes be displayed in green when the camera is unable to focus.

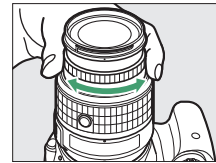
✔ **Manual Focus**

To focus in manual focus mode (M 42), rotate the lens focus ring until the subject is in focus.



To magnify the view in the monitor up to about 9.4 × for precise focus, press the  button. While the view through the lens is zoomed in, a navigation window will appear in a gray frame at the bottom right corner of the display. Use the multi selector to scroll to areas of the frame not visible in the monitor (available only if  (**Wide-area AF**) or  (**Normal-area AF**) is selected for **AF-area mode**), or press  (?) to zoom out.

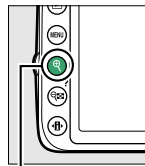

Q button

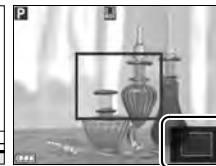

Navigation window



Recording and Viewing Movies

Recording Movies

Movies can be recorded in live view mode.

1 Press the **Lv** button.

The mirror is raised and the view through the lens is displayed in the monitor instead of the viewfinder.

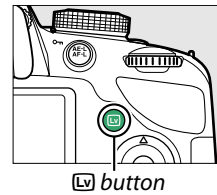

✓ The **Icon**

A  icon (□ 84) indicates that movies can not be recorded.

✓ **Before Recording**

Set aperture before recording in mode **A** or **M**.

2 Focus.

Frame the opening shot and focus as described in Steps 2 and 3 of “Framing Photographs in the Monitor” (□ 80; see also “Focusing in Live View” on pages □ 81–83). Note that the number of subjects that can be detected in face-priority AF drops during movie recording.



3 Start recording.

Press the movie-record button to start recording. A recording indicator and the time available are displayed in the monitor. Except in **AUTO** and **☺** modes, exposure can be locked by pressing the **AE-L/AF-L** () button (□ 61) or (in modes **P**, **S**, and **A**) altered by up to ± 3 EV in steps of $\frac{1}{3}$ EV using exposure compensation (□ 63; note that depending on the brightness of the subject, changes to exposure may have no visible effect).

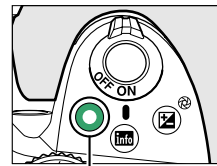

Movie-record button
Recording indicator



Time remaining

4 End recording.

Press the movie-record button again to end recording. Recording will end automatically when the maximum length is reached, the memory card is full, another mode is selected, or the lens is removed.

Taking Photographs During Movie Recording

To end movie recording, take a photograph, and exit to live view, press the shutter-release button all the way down and hold it in this position until the shutter is released.

Maximum Length

Each movie file can be up to 4 GB in size and 20 minutes long; note that depending on memory card write speed, shooting may end before this length is reached (□ 177).

Recording Movies

Flicker, banding, or distortion may be visible in the monitor and in the final movie under fluorescent, mercury vapor, or sodium lamps or if the camera is panned horizontally or an object moves at high speed through frame (flicker and banding can be reduced using **Flicker reduction**; □ 136). Bright light sources may leave after-images when the camera is panned. Jagged edges, color fringing, moiré, and bright spots may also appear. Bright bands may appear in some areas of the frame if the subject is briefly illuminated by a strobe or other bright, momentary light source. When recording movies, avoid pointing the camera at the sun or other strong light sources. Failure to observe this precaution could result in damage to the camera's internal circuitry.

The camera can record both video and sound; do not cover the microphone on the front of the camera during recording. Note that the built-in microphone may record lens noise during autofocus and vibration reduction.

Flash lighting can not be used during movie recording.

Live view may end automatically to prevent damage to the camera's internal circuits; exit live view when the camera is not in use. Note that the temperature of the camera's internal circuits may rise and noise (bright spots, randomly-spaced bright pixels, or fog) may be displayed in the following instances (the camera may also become noticeably warm, but this does not indicate a malfunction):

- The ambient temperature is high
- The camera has been used for extended periods in live view or to record movies
- The camera has been used in continuous release mode for extended periods

If live view does not start when you press the  button, wait for the internal circuits to cool and then try again.

Matrix metering is used regardless of the metering method selected. Shutter speed and ISO sensitivity are adjusted automatically unless **On** is selected for **Manual movie settings** (□ 91) and the camera is in mode **M**.

See Also







For information on the indicators displayed in live view, see page 84. For information on choosing focus and AF-area modes, see page 81. See page 87 for information on focusing in live view.



Movie Settings

Use the **Movie settings** option in the shooting menu to adjust the following settings.

- **Frame size/frame rate, Movie quality:** Choose from the following options. The frame rate depends on the option currently selected for **Video mode** in the setup menu (□ 136):

	Frame size/frame rate		Movie quality	Maximum length
	Frame size (pixels)	Frame rate ¹	Maximum bit rate (Mbps) (★ high quality/Normal)	
	1920 × 1080	30p ²	24/12	20 min.
		25p ³		
		24p		
	1280 × 720	60p ²	5/3	
		50p ³		
	640 × 424	30p ²	5/3	
		25p ³		

¹ Listed value. Actual frame rates for 60p, 50p, 30p, 25p, and 24p are 59.94, 50, 29.97, 25, and 23.976 fps respectively.

² Available when **NTSC** is selected for **Video mode** (□ 136).

³ Available when **PAL** is selected for **Video mode**.

- **Microphone:** Turn the built-in or optional ME-1 stereo microphones (□ 91, 177) on or off or adjust microphone sensitivity. Choose **Auto sensitivity** to adjust sensitivity automatically, **Microphone off** to turn sound recording off; to select microphone sensitivity manually, select **Manual sensitivity** and choose a sensitivity.



HDMI and Other Video Devices

When the camera is connected to a video device, the device will display the indicators shown at right. The camera monitor does not show the sound level, and the  can not be used to hide or display indicators in the monitor or on the video device. If the device supports HDMI-CEC, select **Off** for the **HDMI > Device control** option in the setup menu (□ 124) before shooting in live view.



- Manual movie settings:** Choose **On** to allow manual adjustments to shutter speed and ISO sensitivity when the camera is in mode **M**. Shutter speed can be set to values as fast as $1/4,000$ s; the slowest speed available varies with the frame rate: $1/30$ s for frame rates of 24p, 25p, and 30p, $1/50$ s for 50p, and $1/60$ s for 60p. ISO sensitivity can be set to values between ISO 200 and Hi 1 (□ 51). If shutter speed and ISO sensitivity are not in these ranges when live view starts, they will automatically be set to supported values, and remain at these values when live view ends. Note that ISO sensitivity is fixed at the value selected; the camera does not adjust ISO sensitivity automatically when **On** is selected for **ISO sensitivity settings > Auto ISO sensitivity control** in the shooting menu (□ 129).



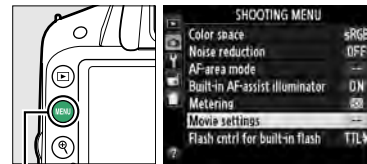

- Select Movie settings.**
 Press the **MENU** button to display the menus. Highlight **Movie settings** in the shooting menu and press ►.



MENU button

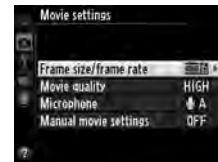

- Choose movie options.**
 Highlight the desired item and press ►, then highlight an option and press **OK**.



 **Using an External Microphone**
 The optional ME-1 stereo microphone (□ 177) can be used to record sound in stereo or to reduce noise caused by lens vibration being recorded during autofocus.







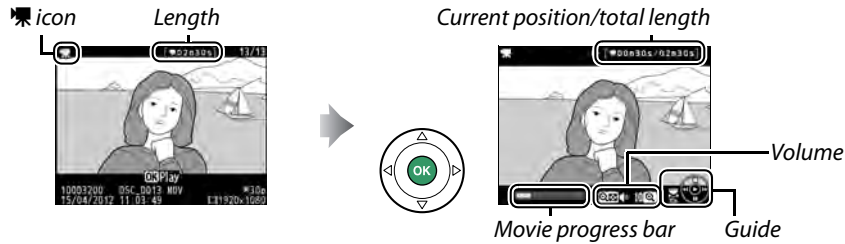





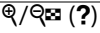

 **The Count-Down Display**
 A count down will be displayed 30 s before live view ends automatically (□ 84). Depending on shooting conditions, the timer may appear immediately when movie recording begins. Note that regardless of the amount of recording time available, live view will still end automatically when the timer expires. Wait for the internal circuits to cool before resuming movie recording.

Viewing Movies

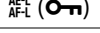
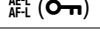
Movies are indicated by a  icon in full-frame playback ( 97). Press  to start playback.



The following operations can be performed:

To	Use	Description
Pause		Pause playback.
Play		Resume playback when movie is paused or during rewind/advance.
 Advance/rewind		Speed increases with each press, from 2x to 4x to 8x to 16x; keep pressed to skip to beginning or end of movie (first frame is indicated by  in top right corner of monitor, last frame by ). If playback is paused, movie rewinds or advances one frame at a time; hold for continuous rewind or advance.
Skip 10 s		Rotate the command dial to skip ahead or back 10 s.
Adjust volume		Press  to increase volume,  (?) to decrease.
Edit movie		To edit movie, press  while movie is paused ( 93).
Return to full-frame playback	 / 	Press  or  to exit to full-frame playback.
Exit to shooting mode		Press shutter-release button halfway. Monitor will turn off; photographs can be taken immediately.



The Icon

 is displayed in full-frame and movie playback if the movie was recorded without sound.





Editing Movies

Trim footage to create edited copies of movies or save selected frames as JPEG stills.



Option	Description
 Choose start/end point	Create a copy from which the opening or closing footage has been removed.
 Save selected frame	Save a selected frame as a JPEG still.

Trimming Movies

To create trimmed copies of movies:

- 1 Display a movie full frame.**
Press the  button to display pictures full frame in the monitor and press  and  to scroll through pictures until the movie you wish to edit is displayed.



- 2 Choose a starting or end point.**
Play the movie back as described on page 92, pressing  to start and resume playback and  to pause. Your approximate position in the movie can be ascertained from the movie progress bar.



- 3 Display movie edit options.**
Press the  button to display movie edit options.

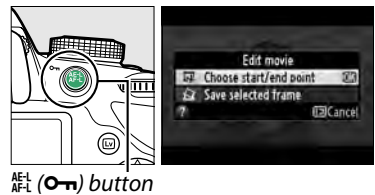

4 Select **Choose start/end point**.

Highlight **Choose start/end point** and press **OK**.

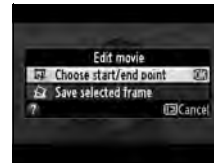

The dialog shown at right will be displayed; choose whether the current frame will be the starting or end point of the copy and press **OK**.



5 Delete frames.

If the desired frame is not currently displayed, press **◀** or **▶** to advance or rewind (to skip to 10 s ahead or back, rotate the command dial). To switch the current selection from start point (**⏪**) to end point (**⏩**) or vice versa, press **AE-L** (**⏪**).

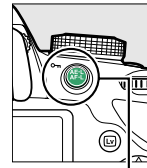

AE-L (**⏪**) button

Once you have selected the start point and/or end point, press **▲**. All frames before the selected start point and after the selected end point will be removed from the copy.



6 Save the copy.

Highlight one of the following and press **OK**:

- **Save as new file**: Save the copy to a new file.
- **Overwrite existing file**: Replace the original movie file with the edited copy.
- **Cancel**: Return to Step 5.
- **Preview**: Preview the copy.



Except in the photo information "image only" page (98), edited copies are indicated by a  icon in full-frame playback.

✔ **Trimming Movies**

Movies must be at least two seconds long. If a copy can not be created at the current playback position, the current position will be displayed in red in Step 5 and no copy will be created. The copy will not be saved if there is insufficient space available on the memory card.

Copies have the same time and date of creation as the original.

✍ **The Retouch Menu**

Movies can also be edited using the **Edit movie** option in the retouch menu (☐ 149).



Saving Selected Frames

To save a copy of a selected frame as a JPEG still:

1 View the movie and choose a frame.

Play the movie back as described on page 92; your approximate position in the movie can be ascertained from the movie progress bar. Pause the movie at the frame you intend to copy.



2 Display movie edit options.

Press the AE-L/AF-L (OK) button to display movie edit options.

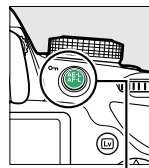

AE-L/AF-L (OK) button



3 Choose Save selected frame.

Highlight **Save selected frame** and press OK .



4 Create a still copy.

Press \blacktriangle to create a still copy of the current frame.



5 Save the copy.

Highlight **Yes** and press OK to create a fine-quality (44) JPEG copy of the selected frame. Except in the photo information "image only" page (98), movie stills are indicated by a  icon in full-frame playback.



Save Selected Frame

JPEG movie stills created with the **Save selected frame** option can not be retouched. JPEG movie stills lack some categories of photo information (98).



Playback and Deletion

Full-Frame Playback

To play photographs back, press the  button. The most recent photograph will be displayed in the monitor.



 button















To	Use	Description
View additional photographs		Press  to view photographs in order recorded,  to view photographs in reverse order.
View additional photo info		Change photo info displayed (book 98).
View thumbnails		See page 102 for more information on the thumbnail display.
Zoom in on photograph		See page 104 for more information on playback zoom.
Delete images		Confirmation dialog will be displayed. Press  again to delete photo.
Change protect status		To protect image, or to remove protection from protected image, press  button (book 105).
Return to shooting mode		Press shutter-release button halfway. Monitor will turn off; photographs can be taken immediately.
Retouch photo or play movie		Create retouched copy of current photograph (book 149). If current picture is marked with  icon to show that it is a movie, pressing  starts movie playback (book 92).

Photo Information

Photo information is superimposed on images displayed in full-frame playback. Press ▲ or ▼ to cycle through photo information as shown below. Note that “image only”, shooting data, RGB histograms, highlights, and overview data are only displayed if corresponding option is selected for **Playback display options** > **Additional photo info** (□ 126). GPS data are only displayed if a GP-1 was used when the photo was taken.



File Information

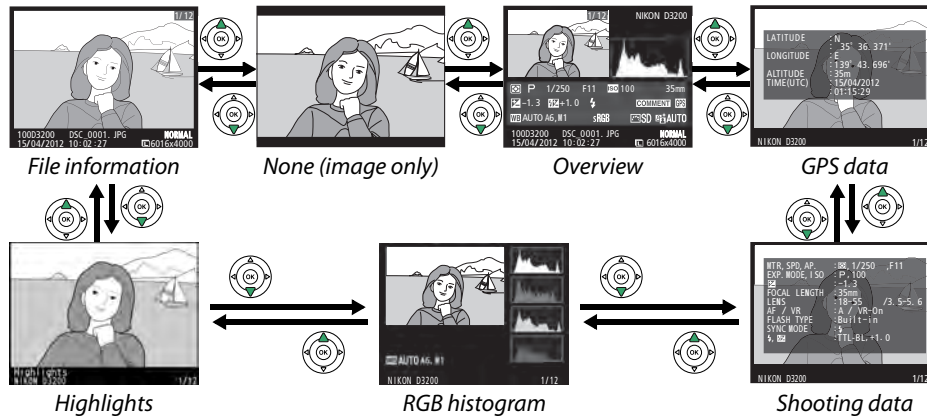
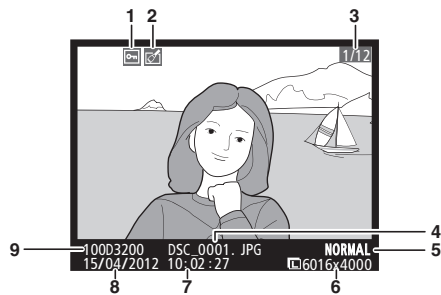

1	Protect status.....	105
2	Retouch indicator	150
3	Frame number/total number of images	
4	File name.....	188
5	Image quality	44
6	Image size.....	46
7	Time of recording.....	16, 137
8	Date of recording	16, 137
9	Folder name	146

Highlights*

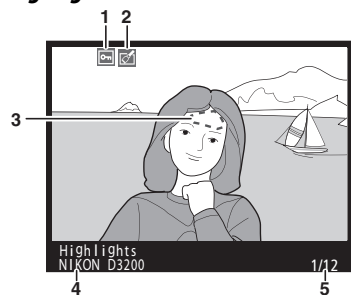

1	Protect status.....	105
2	Retouch indicator	150
3	Image highlights	
4	Camera name	
5	Frame number/total number of images	

* Flashing areas indicate highlights (areas that may be overexposed).

■ ■ RGB Histogram

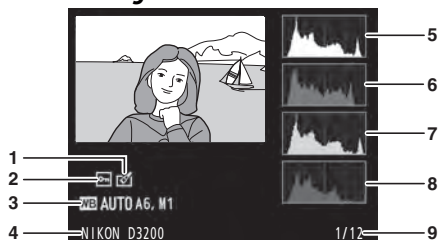

1	Retouch indicator	150
2	Protect status	105
3	White balance	69
	White balance fine-tuning.....	71
	Preset manual	72
4	Camera name	
5	Histogram (RGB channel). In all histograms, horizontal axis gives pixel brightness, vertical axis number of pixels.	
6	Histogram (red channel)	
7	Histogram (green channel)	
8	Histogram (blue channel)	
9	Frame number/total number of images	

Playback Zoom

To zoom in on the photograph when the histogram is displayed, press . Use the and (?) buttons to zoom in and out and scroll the image with the multi selector. The histogram will be updated to show only the data for the portion of the image visible in the monitor.



Histograms

Camera histograms are intended as a guide only and may differ from those displayed in imaging applications. Some sample histograms are shown below:

If the image contains objects with a wide range of brightnesses, the distribution of tones will be relatively even.



If the image is dark, tone distribution will be shifted to the left.



If the image is bright, tone distribution will be shifted to the right.

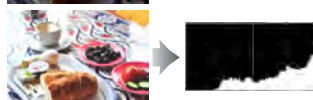

Increasing exposure compensation shifts the distribution of tones to the right, while decreasing exposure compensation shifts the distribution to the left. Histograms can provide a rough idea of overall exposure when bright ambient lighting makes it difficult to see photographs in the monitor.

Shooting Data

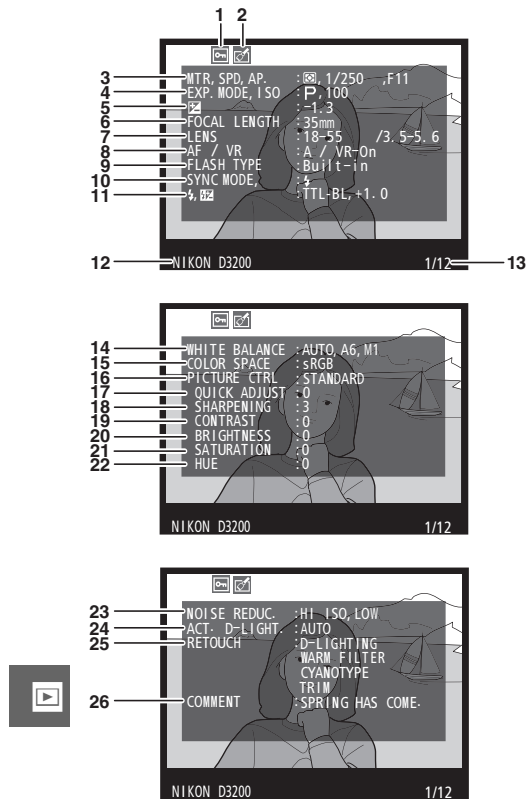

1	Protect status	105
2	Retouch indicator	150
3	Metering	60
	Shutter speed	55, 57
	Aperture.....	57
4	Shooting mode	22, 25, 27, 53
	ISO sensitivity ¹	51
5	Exposure compensation	63
6	Focal length.....	171
7	Lens data	
8	Focus mode	35, 81
	Lens VR (vibration reduction) ²	205
9	Flash type	132
	Commander mode ³	
10	Flash mode	48
11	Flash control.....	132
	Flash compensation	65
12	Camera name	
13	Frame number/total number of images	
14	White balance.....	69
	White balance fine-tuning.....	71
	Preset manual.....	72
15	Color space	130
16	Picture Control.....	76
17	Quick adjust ⁴	78
	Original Picture Control ⁵	77
18	Sharpening	78
19	Contrast.....	78
20	Brightness	78
21	Saturation ⁶	78
	Filter effects ⁷	78
22	Hue ⁶	78
	Toning ⁷	78
23	Noise reduction.....	131
24	Active D-Lighting ⁸	67
25	Retouch history.....	149
26	Image comment	138

- 1 Displayed in red if photo was taken with auto ISO sensitivity control on.
- 2 Displayed only if VR lens is attached.
- 3 Displayed only if photo was taken using optional flash unit with commander function.
- 4 **Standard**, **Vivid**, **Portrait**, and **Landscape** Picture Controls only.
- 5 **Neutral** and **Monochrome** Picture Controls only.
- 6 Not displayed with monochrome Picture Controls.
- 7 Monochrome Picture Controls only.
- 8 **AUTO** is displayed if photo was taken with Active D-Lighting on.

■ Overview Data

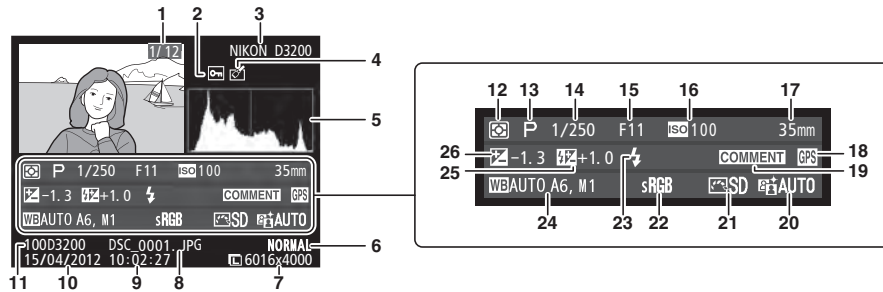

<table border="0"> <tr><td>1</td><td>Frame number/total number of images</td><td></td></tr> <tr><td>2</td><td>Protect status</td><td>105</td></tr> <tr><td>3</td><td>Camera name</td><td></td></tr> <tr><td>4</td><td>Retouch indicator</td><td>150</td></tr> <tr><td>5</td><td>Histogram showing the distribution of tones in the image (☐ 99).</td><td></td></tr> <tr><td>6</td><td>Image quality</td><td>44</td></tr> <tr><td>7</td><td>Image size</td><td>46</td></tr> <tr><td>8</td><td>File name</td><td>188</td></tr> <tr><td>9</td><td>Time of recording</td><td>16, 137</td></tr> <tr><td>10</td><td>Date of recording</td><td>16, 137</td></tr> <tr><td>11</td><td>Folder name</td><td>146</td></tr> <tr><td>12</td><td>Metering</td><td>60</td></tr> <tr><td>13</td><td>Shooting mode</td><td>22, 25, 27, 53</td></tr> <tr><td>14</td><td>Shutter speed</td><td>55, 57</td></tr> <tr><td>15</td><td>Aperture</td><td>56, 57</td></tr> <tr><td>16</td><td>ISO sensitivity¹</td><td>51</td></tr> <tr><td>17</td><td>Focal length</td><td>171</td></tr> <tr><td>18</td><td>GPS data indicator</td><td>147</td></tr> <tr><td>19</td><td>Image comment indicator</td><td>138</td></tr> <tr><td>20</td><td>Active D-Lighting²</td><td>67</td></tr> <tr><td>21</td><td>Picture Control</td><td>76</td></tr> <tr><td>22</td><td>Color space</td><td>130</td></tr> <tr><td>23</td><td>Flash mode</td><td>48</td></tr> <tr><td>24</td><td>White balance</td><td>69</td></tr> <tr><td></td><td>White balance fine-tuning</td><td>71</td></tr> <tr><td></td><td>Preset manual</td><td>72</td></tr> <tr><td>25</td><td>Flash compensation</td><td>65</td></tr> <tr><td></td><td>Commander mode³</td><td></td></tr> <tr><td>26</td><td>Exposure compensation</td><td>63</td></tr> </table>	1	Frame number/total number of images		2	Protect status	105	3	Camera name		4	Retouch indicator	150	5	Histogram showing the distribution of tones in the image (☐ 99).		6	Image quality	44	7	Image size	46	8	File name	188	9	Time of recording	16, 137	10	Date of recording	16, 137	11	Folder name	146	12	Metering	60	13	Shooting mode	22, 25, 27, 53	14	Shutter speed	55, 57	15	Aperture	56, 57	16	ISO sensitivity ¹	51	17	Focal length	171	18	GPS data indicator	147	19	Image comment indicator	138	20	Active D-Lighting ²	67	21	Picture Control	76	22	Color space	130	23	Flash mode	48	24	White balance	69		White balance fine-tuning	71		Preset manual	72	25	Flash compensation	65		Commander mode ³		26	Exposure compensation	63	<table border="0"> <tr><td>15</td><td>Aperture</td><td>56, 57</td></tr> <tr><td>16</td><td>ISO sensitivity¹</td><td>51</td></tr> <tr><td>17</td><td>Focal length</td><td>171</td></tr> <tr><td>18</td><td>GPS data indicator</td><td>147</td></tr> <tr><td>19</td><td>Image comment indicator</td><td>138</td></tr> <tr><td>20</td><td>Active D-Lighting²</td><td>67</td></tr> <tr><td>21</td><td>Picture Control</td><td>76</td></tr> <tr><td>22</td><td>Color space</td><td>130</td></tr> <tr><td>23</td><td>Flash mode</td><td>48</td></tr> <tr><td>24</td><td>White balance</td><td>69</td></tr> <tr><td></td><td>White balance fine-tuning</td><td>71</td></tr> <tr><td></td><td>Preset manual</td><td>72</td></tr> <tr><td>25</td><td>Flash compensation</td><td>65</td></tr> <tr><td></td><td>Commander mode³</td><td></td></tr> <tr><td>26</td><td>Exposure compensation</td><td>63</td></tr> </table>	15	Aperture	56, 57	16	ISO sensitivity ¹	51	17	Focal length	171	18	GPS data indicator	147	19	Image comment indicator	138	20	Active D-Lighting ²	67	21	Picture Control	76	22	Color space	130	23	Flash mode	48	24	White balance	69		White balance fine-tuning	71		Preset manual	72	25	Flash compensation	65		Commander mode ³		26	Exposure compensation	63
1	Frame number/total number of images																																																																																																																																				
2	Protect status	105																																																																																																																																			
3	Camera name																																																																																																																																				
4	Retouch indicator	150																																																																																																																																			
5	Histogram showing the distribution of tones in the image (☐ 99).																																																																																																																																				
6	Image quality	44																																																																																																																																			
7	Image size	46																																																																																																																																			
8	File name	188																																																																																																																																			
9	Time of recording	16, 137																																																																																																																																			
10	Date of recording	16, 137																																																																																																																																			
11	Folder name	146																																																																																																																																			
12	Metering	60																																																																																																																																			
13	Shooting mode	22, 25, 27, 53																																																																																																																																			
14	Shutter speed	55, 57																																																																																																																																			
15	Aperture	56, 57																																																																																																																																			
16	ISO sensitivity ¹	51																																																																																																																																			
17	Focal length	171																																																																																																																																			
18	GPS data indicator	147																																																																																																																																			
19	Image comment indicator	138																																																																																																																																			
20	Active D-Lighting ²	67																																																																																																																																			
21	Picture Control	76																																																																																																																																			
22	Color space	130																																																																																																																																			
23	Flash mode	48																																																																																																																																			
24	White balance	69																																																																																																																																			
	White balance fine-tuning	71																																																																																																																																			
	Preset manual	72																																																																																																																																			
25	Flash compensation	65																																																																																																																																			
	Commander mode ³																																																																																																																																				
26	Exposure compensation	63																																																																																																																																			
15	Aperture	56, 57																																																																																																																																			
16	ISO sensitivity ¹	51																																																																																																																																			
17	Focal length	171																																																																																																																																			
18	GPS data indicator	147																																																																																																																																			
19	Image comment indicator	138																																																																																																																																			
20	Active D-Lighting ²	67																																																																																																																																			
21	Picture Control	76																																																																																																																																			
22	Color space	130																																																																																																																																			
23	Flash mode	48																																																																																																																																			
24	White balance	69																																																																																																																																			
	White balance fine-tuning	71																																																																																																																																			
	Preset manual	72																																																																																																																																			
25	Flash compensation	65																																																																																																																																			
	Commander mode ³																																																																																																																																				
26	Exposure compensation	63																																																																																																																																			

- 1 Displayed in red if photo was taken with ISO sensitivity auto control on.
- 2 **AUTO** is displayed if photo was taken with Active D-Lighting on.
- 3 Displayed only if photo was taken using optional flash unit with commander function.

■ GPS Data*

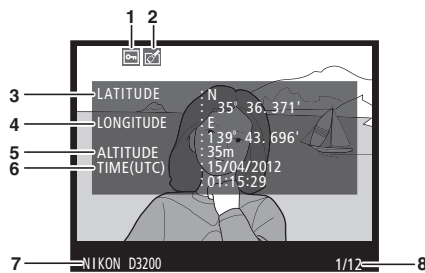









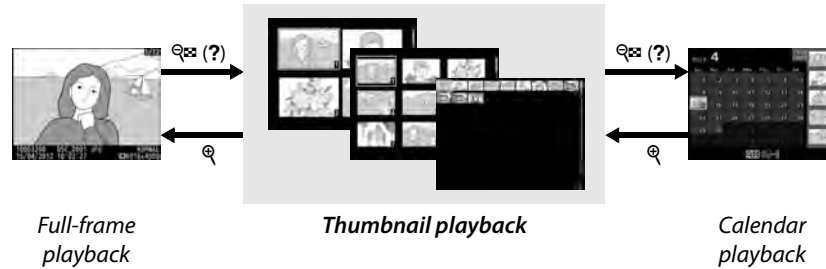





1	Protect status	105
2	Retouch indicator	150
3	Latitude	
4	Longitude	
5	Altitude	
6	Coordinated Universal Time (UTC)	
7	Camera name	
8	Frame number/total number of images	

* Data for movies are for start of recording.

Thumbnail Playback

To display images in “contact sheets” of four, nine, or 72 images, press the  (?) button.









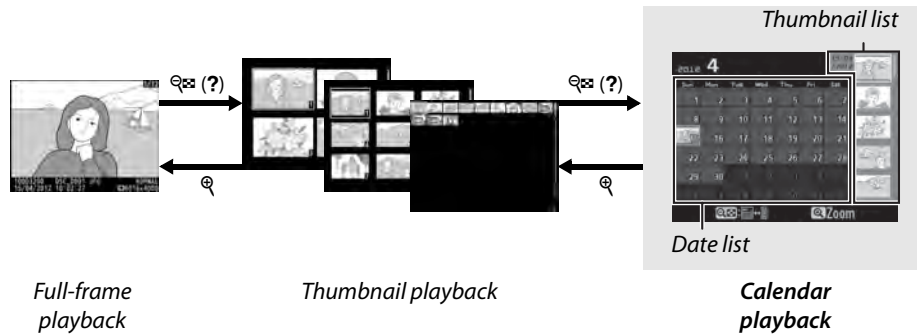

To	Use	Description
Display more images	 (?)	Press  (?) button to increase the number of images displayed.
Display fewer images		Press  button to reduce the number of images displayed. When four images are displayed, press to view highlighted image full frame.
Highlight images		Use multi selector or command dial to highlight images for full-frame playback, playback zoom ( 104), deletion ( 106), or protection ( 105).
View highlighted image		Press  to display the highlighted image full frame.
Delete highlighted photo		See page 106 for more information.
Change protect status of highlighted photo		See page 105 for more information.
Return to shooting mode		Press shutter-release button halfway. Monitor will turn off; photographs can be taken immediately.

Calendar Playback

To view images taken on a selected date, press the  button when 72 images are displayed.





















The operations can be performed depend on whether the cursor is in the date list or the thumbnail list:

To	Use	Description
Toggle between date list and thumbnail list		Press  button in date list to place cursor in thumbnail list. Press again to return to date list.
Exit to thumbnail playback/Zoom in on highlighted photo		<ul style="list-style-type: none"> Date list: Exit to 72-frame playback. Thumbnail list: Press and hold  button to zoom in on highlighted picture.
Highlight dates/Highlight images		<ul style="list-style-type: none"> Date list: Highlight date. Thumbnail list: Highlight picture.
Toggle full frame playback		<ul style="list-style-type: none"> Date list: View pictures taken on selected date. Thumbnail list: View highlighted picture.
Delete highlighted photo(s)		<ul style="list-style-type: none"> Date list: Delete all pictures taken on selected date. Thumbnail list: Delete highlighted picture (📖 106).
Change protect status of highlighted photo		See page 105 for more information.
Return to shooting mode		Press shutter-release button halfway. Monitor will turn off; photographs can be taken immediately.

Taking a Closer Look: Playback Zoom

Press the  button to zoom in on the image displayed in full-frame playback or on the image currently highlighted in thumbnail or calendar playback. The following operations can be performed while zoom is in effect:

To	Use	Description
Zoom in or out	 /  (?)	Press  to zoom in to maximum of approximately 38× (large images), 28× (medium images) or 19× (small images). Press  (?) to zoom out. While photo is zoomed in, use multi selector to view areas of image not visible in monitor. Keep multi selector pressed to scroll rapidly to other areas of frame. Navigation window is displayed when zoom ratio is altered; area currently visible in monitor is indicated by yellow border. 
View other areas of image		While photo is zoomed in, use multi selector to view areas of image not visible in monitor. Keep multi selector pressed to scroll rapidly to other areas of frame. Navigation window is displayed when zoom ratio is altered; area currently visible in monitor is indicated by yellow border.
Select/zoom in on or out from faces	 + 	Faces (up to 35) detected during zoom are indicated by white borders in navigation window. Press  and  or  to zoom in or out; press  and  or  to view other faces. 
View other images		Rotate command dial to view same location in other images at current zoom ratio. Playback zoom is cancelled when a movie is displayed.
Cancel zoom		Cancel zoom and return to full-frame playback.
Change protect status		See page 105 for more information.
Return to shooting mode		Press shutter-release button halfway. Monitor will turn off; photographs can be taken immediately.

Protecting Photographs from Deletion

In full-frame, zoom, thumbnail, and calendar playback, the **AE-L/AF-L** (**OK**) button can be used to protect photographs from accidental deletion. Protected files can not be deleted using the **DEL** button or the **Delete** option in the playback menu. Note that protected images *will* be deleted when the memory card is formatted (19).

To protect a photograph:

1 Select an image.

Display the image in full-frame playback or playback zoom or highlight it in the thumbnail list in thumbnail or calendar playback.



Full-frame playback



Thumbnail playback



Calendar playback

2 Press the **AE-L/AF-L** (**OK**) button.

The photograph will be marked with a **PROT** icon. To remove protection from the photograph so that it can be deleted, display the photograph or highlight it in the thumbnail list and then press the **AE-L/AF-L** (**OK**) button.

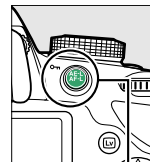

AE-L/AF-L (**OK**) button



Removing Protection from All Images

To remove protection from all images in the folder or folders currently selected in the **Playback folder** menu (125), press the **AE-L/AF-L** (**OK**) and **DEL** buttons together for about two seconds during playback.

Deleting Photographs

To delete the photograph displayed in full-frame playback or the photograph highlighted in the thumbnail list, press the  button. To delete multiple selected photographs, all photographs taken on a selected date, or all photographs in the current playback folder, use the **Delete** option in the playback menu. Once deleted, photographs can not be recovered.

Full-Frame, Thumbnail, and Calendar Playback

1 Select an image.

Display the image or highlight it in the thumbnail list in thumbnail or calendar playback.

2 Press the button.

A confirmation dialog will be displayed.

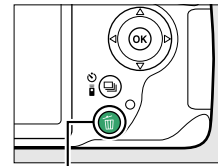

 button



Full-frame playback





Thumbnail playback



Calendar playback
(thumbnail list)

3 Press the button again.

To delete the photograph, press the  button again. To exit without deleting the photograph, press the  button.

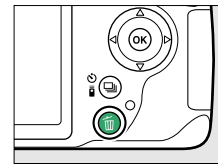



Calendar Playback

During calendar playback, you can delete all photographs taken on a selected date by highlighting the date in the date list and pressing the  button ([103](#)).

The Playback Menu

The **Delete** option in the playback menu contains the following options. Note that depending on the number of images, some time may be required for deletion.

Option	Description
 Selected	Delete selected pictures.
 Select date	Delete all pictures taken on a selected date.
ALL All	Delete all pictures in the folder currently selected for playback ( 125).

■ Selected: Deleting Selected Photographs

1 Select Delete.

To display the menus, press the **MENU** button. Highlight **Delete** in the playback menu and press **▶**.

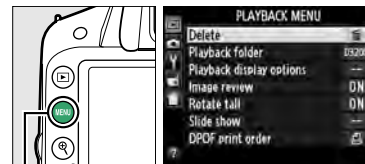

MENU button

2 Choose Selected.

Highlight **Selected** and press **▶**.



3 Highlight a picture.

Use the multi selector to highlight a picture (to view the highlighted picture full screen, press and hold the **Q** button).



4 Select the highlighted picture.

Press the **Q** button (?) to select the highlighted picture. Selected pictures are marked by a  icon. Repeat steps 3 and 4 to select additional pictures; to deselect a picture, highlight it and press **Q** button (?).

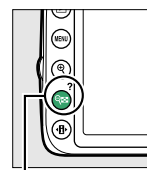

Q (?) button



5 Press **OK** to complete the operation.

A confirmation dialog will be displayed; highlight **Yes** and press **OK**.

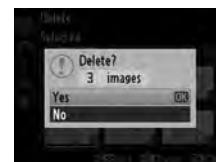

■ ■ Select Date: Deleting Photographs Taken on a Selected Date

1 Choose Select Date.

In the delete menu, highlight **Select date** and press **▶**.



2 Highlight a date.

Press **▲** or **▼** to highlight a date.



To view the pictures taken on the highlighted date, press **Q** (?). Use the multi-selector to scroll through the pictures, or press and hold **Q** to view the current picture full screen. Press **Q** (?) to return to the date list.

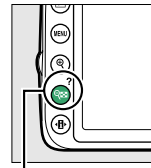

Q (?) button



3 Select the highlighted date.

Press **▶** to select all pictures taken on the highlighted date. Selected dates are marked with a **☑** icon. Repeat steps 2 and 3 to select additional dates; to deselect a date, highlight it and press **▶**.



4 Press **OK** to complete the operation.

A confirmation dialog will be displayed; highlight **Yes** and press **OK**.

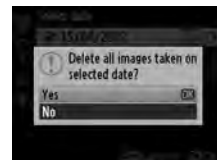

Slide Shows

The **Slide show** option in the playback menu is used to display a slide show of the pictures in the current playback folder (□ 125).

1 Select Slide show.

To display the slide show menu, press the **MENU** button and select **Slide show** in the playback menu.

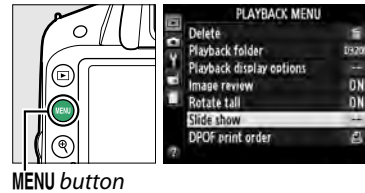

2 Adjust slide show settings.

To choose the type of images in the show, select **Image type** and choose from **Still images and movies**, **Still images only**, and **Movies only**.



To choose how long still images are displayed, select **Frame interval** and choose from the options shown at right.

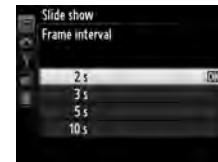

To choose the transition between still images, select **Transition effects** and choose from the following options:

- **Zoom/fade:** Frames fade into one another with a zoom effect.
- **Cube:** This transition takes the form of a rotating cube with the current picture on one face and the next picture on another.
- **None:** No transition between frames.

3 Start the side show.

Highlight **Start** in the slide show menu and press **OK**.

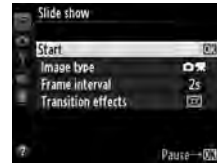

The following operations can be performed while the slide show is in progress:

To	Use	Description
Skip back/skip ahead		Press ◀ to return to previous frame, ▶ to skip to next frame.
View additional photo info		Change photo info displayed (📄 98).
Pause/resume slide show		Pause show. Press again to resume.
Raise/lower volume		Press 🔊 during movie playback to increase volume, 🔇 (?) to decrease.
Exit to playback mode		End show and return to playback mode.
Exit to shooting mode		Press shutter-release button halfway. Monitor will turn off; photographs can be taken immediately.



The dialog shown at right is displayed when the show ends. Select **Restart** to restart or **Exit** to return to the playback menu.





Connections

Connecting to a Computer

This section describes how to use the supplied UC-E17 USB cable to connect the camera to a computer.

Before Connecting the Camera

Before connecting the camera, install the software on the supplied ViewNX 2 CD. To ensure that data transfer is not interrupted, be sure the camera EN-EL14 battery is fully charged. If in doubt, charge the battery before use or use an EH-5b AC adapter and EP-5A power connector (available separately).

■ Supplied Software

ViewNX 2 includes a "Nikon Transfer 2" function for copying pictures from the camera to the computer, where ViewNX 2 can be used to view and print selected images or to edit photographs and movies. For more information, see ViewNX 2 online help.

■ Supported Operating Systems

The supplied software can be used with computers running the following operating systems:

- **Windows:** Pre-installed versions of Windows 7 Home Basic/Home Premium/Professional/Enterprise/Ultimate (Service Pack 1), Windows Vista Home Basic/Home Premium/Business/Enterprise/Ultimate (Service Pack 2), or 32-bit editions of Windows XP Home Edition/Professional (Service Pack 3). All installed programs may run as 32-bit applications in 64-bit editions of Windows 7 and Windows Vista. This application is not compatible with computers running 64-bit Windows XP.
- **Macintosh:** Mac OS X (version 10.5.8, 10.6.8, or 10.7.2)

See the websites listed on page xiv for the latest information on supported operating systems.

Connecting Cables

Be sure the camera is off when connecting or disconnecting interface cables. Do not use force or attempt to insert the connectors at an angle. Close the connector cover when the connector is not in use.

During Transfer

Do not turn the camera off or disconnect the USB cable while transfer is in progress.

Windows

To visit the Nikon website after installing ViewNX 2, select **All Programs > Link to Nikon** from the Windows start menu (Internet connection required).

Connecting the Camera

Connect the camera using the supplied UC-E17 USB cable.

- 1 Turn the camera off.**
- 2 Turn the computer on.**
Turn the computer on and wait for it to start up.
- 3 Connect the USB cable.**
Connect the USB cable as shown.

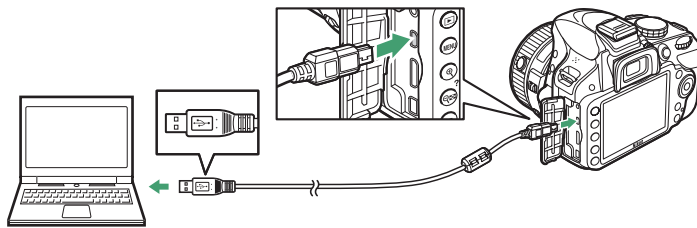

✓ USB Hubs

Connect the camera directly to the computer; do not connect the cable via a USB hub or keyboard.

- 4 Turn the camera on.**



- 5 Start Nikon Transfer 2.**

If a message is displayed prompting you to choose a program, select Nikon Transfer 2.

✓ Windows 7

If the following dialog is displayed, select Nikon Transfer 2 as described below.

- Under **Import pictures and videos**, click **Change program**. A program selection dialog will be displayed; select **Import file using Nikon Transfer 2** and click **OK**.
- Double-click **Import file**.



6 Click Start Transfer.

At default settings, all the pictures on the memory card will be copied to the computer (for more information on using Nikon Transfer 2, start ViewNX 2 or Nikon Transfer 2 and select **ViewNX 2 Help** from the **Help** menu).



Start Transfer

7 Turn the camera off and disconnect the USB cable when transfer ends.

Nikon Transfer 2 will close automatically when transfer is complete.



Printing Photographs

Selected JPEG images can be printed on a PictBridge printer (☞ 208) connected directly to the camera.

Connecting the Printer

Connect the camera using the supplied UC-E17 USB cable.

1 Turn the camera off.

2 Connect the USB cable.

Turn the printer on and connect the USB cable as shown. Do not use force or attempt to insert the connectors at an angle.

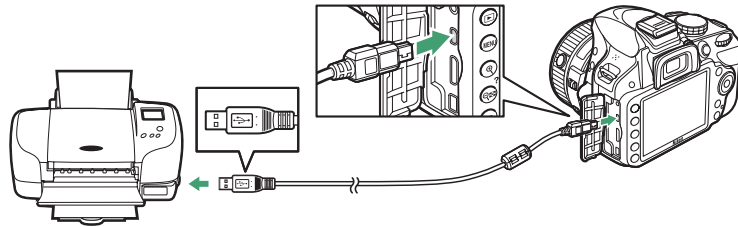

USB Hubs

Connect the camera directly to the printer; do not connect the cable via a USB hub.



3 Turn the camera on.

A welcome screen will be displayed in the monitor, followed by a PictBridge playback display.



✓ Selecting Photographs for Printing

NEF (RAW) photographs (□ 44) can not be selected for printing. JPEG copies of NEF (RAW) images can be created using the **NEF (RAW) processing** option in the retouch menu (□ 157).

✓ Printing Via Direct USB Connection



Be sure the EN-EL14 battery is fully charged or use an optional EH-5b AC adapter and EP-5A power connector. When taking photographs to be printed via direct USB connection, set **Color space** to **sRGB** (□ 130).

✓ See Also

See page 193 for information on what to do if an error occurs during printing.

Printing Pictures One at a Time

1 Select a picture.

Press ◀ or ▶ to view additional pictures. Press the  button to zoom in on the current frame (□ 104; press ▶ to exit zoom). To view six pictures at a time, press the  (?). Use the multi selector to highlight pictures, or press  to display the highlighted picture full frame.

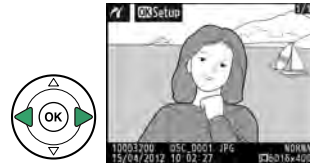

2 Display printing options.

Press  to display PictBridge printing options.



3 Adjust printing options.

Press ▲ or ▼ to highlight an option and press ► to select.

Option	Description
Page size	Highlight a page size (only sizes supported by the current printer are listed) and press OK to select and exit to the previous menu (to print at the default page size for the current printer, select Printer default).
No. of copies	Press ▲ or ▼ to choose number of copies (maximum 99), then press OK to select and return to the previous menu.
Border	This option is available only if supported by the printer. Highlight Printer default (use current printer settings), Print with border (print photo with white border), or No border and press OK to select and exit to the previous menu.
Time stamp	Highlight Printer default (use current printer settings), Print time stamp (print times and dates of recording on photos), or No time stamp and press OK to select and exit to the previous menu.
Cropping	This option is available only if supported by the printer. To exit without cropping, highlight No cropping and press OK. To crop the current picture, highlight Crop and press ►. Selecting Crop displays the dialog shown at right. Press Ⓔ to increase the size of the crop, Ⓔ (?) to decrease. Position the crop using the multi selector and press OK. Note that print quality may drop if small crops are printed at large sizes.



4 Start printing.

Select **Start printing** and press OK to start printing. To cancel before all copies have been printed, press OK.



✓ Date Imprint

If you select **Print time stamp** in the PictBridge menu when printing photographs containing date information recorded using **Print date** in the setup menu (☐ 144), the date will appear twice. The imprinted date may however be cropped out if the photographs are cropped or printed without a border.

Printing Multiple Pictures

- 1 Display the PictBridge menu.**
Press the **MENU** button in the PictBridge playback display (see Step 3 on page 114).



MENU button









- 2 Choose an option.**
Highlight one of the following options and press **▶**.

- **Print select:** Select pictures for printing.
- **Select date:** Print one copy of all the pictures taken on a selected date.
- **Print (DPOF):** Print an existing print order created with the **DPOF print order** option in the playback menu (□ 120). The current print order will be displayed in Step 3.
- **Index print:** To create an index print of all JPEG pictures on the memory card, proceed to Step 4. Note that if the memory card contains more than 256 pictures, only the first 256 images will be printed.





3 Select pictures or choose a date.

If you chose Print select or Print (DPOF) in

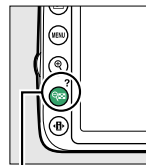



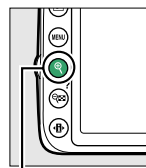

Step 2, use the multi selector to scroll through the pictures on the memory card. To display the current picture full screen, press and hold the  button. To select the current picture for printing, press the  (?) button and press . The picture will be marked with a  icon and the number of prints will be set to 1. Keeping the  (?) button pressed, press  or  to specify the number of prints (up to 99; to deselect the picture, press  when the number of prints is 1). Continue until all the desired pictures have been selected.



 (?) +  / : Choose number of copies



 button: View photo full screen

If you chose Select date in Step 2, press  or  to highlight a date and press  to toggle the highlighted date on or off. To view the pictures taken on the selected date, press  (?). Use the multi selector to scroll through the pictures, or press and hold  to view the current picture full screen. Press  (?) again to return to the date selection dialog.



 button: View highlighted photo full screen

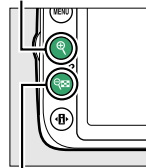

 (?) button: View photos for selected date



4 Display printing options.

Press **OK** to display PictBridge printing options.



5 Adjust printing options.

Choose page size, border, and time stamp options as described on page 116 (a warning will be displayed if the selected page size is too small for an index print).

6 Start printing.

Select **Start printing** and press **OK** to start printing. To cancel before all copies have been printed, press **OK**.



Creating a DPOF Print Order: Print Set

The **DPOF print order** option in the playback menu is used to create digital “print orders” for PictBridge-compatible printers and devices that support DPOF.

1 Choose Select/set for the DPOF print order item in the playback menu.

Press the **MENU** button and select **DPOF print order** in the playback menu. Highlight **Select/set** and press **▶** (to remove all photographs from the print order, select **Deselect all?**).



MENU button

2 Select pictures.

Use the multi selector to scroll through the pictures on the memory card. To display the current picture in full screen, press and hold the **Q** button. To select the current picture for printing, press the **Q(?)** button and press **▲**. The picture will be marked with a **U** icon and the number of prints will be set to 1. Keeping the **Q(?)** button pressed, press **▲** or **▼** to specify the number of prints (up to 99; to deselect the picture, press **▼** when the number of prints is 1). Continue until all the desired pictures have been selected.

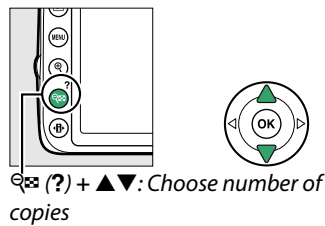

Q(?) + ▲▼: Choose number of copies



Q button: View photo full screen

3 Display imprint options.

Press **OK** to display data imprint options.



4 Select imprint options.

Highlight the following options and press ► to toggle the highlighted option on or off (to complete the print order without including this information, proceed to Step 5).

- **Print shooting data:** Print shutter speed and aperture on all pictures in print order.
- **Print date:** Print date of recording on all pictures in print order.

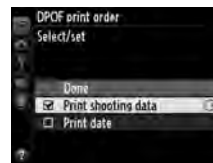

5 Complete the print order.

Highlight **Done** and press OK to complete the print order.

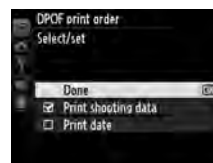

✔ DPOF print order

To print the current print order when the camera is connected to a PictBridge printer, select **Print (DPOF)** in the PictBridge menu and follow the steps in “Printing Multiple Pictures” to modify and print the current order (☞ 117). DPOF print date and shooting data options are not supported when printing via direct USB connection; to print the date of recording on photographs in the current print order, use the PictBridge **Time stamp** option.

The **DPOF print order** option can not be used if there is not enough space on the memory card to store the print order.

NEF (RAW) photographs (☞ 44) can not be selected using this option. JPEG copies of NEF (RAW) images can be created using the **NEF (RAW) processing** option in the retouch menu (☞ 157).

Print orders may not print correctly if images are deleted using a computer or other device after the print order is created.

Viewing Photographs on TV

The supplied EG-CP14 audio video (A/V) cable can be used to connect the camera to a television or video recorder for playback or recording. A type C mini-pin High-Definition Multimedia Interface (HDMI) cable (available separately from third-party suppliers) can be used to connect the camera to high-definition video devices.

Standard Definition Devices

Before connecting the camera to a standard television, confirm that the camera video standard (□ 136) matches that used in the TV.

1 Turn the camera off.

Always turn the camera off before connecting or disconnecting the A/V cable.

2 Connect the A/V cable as shown.

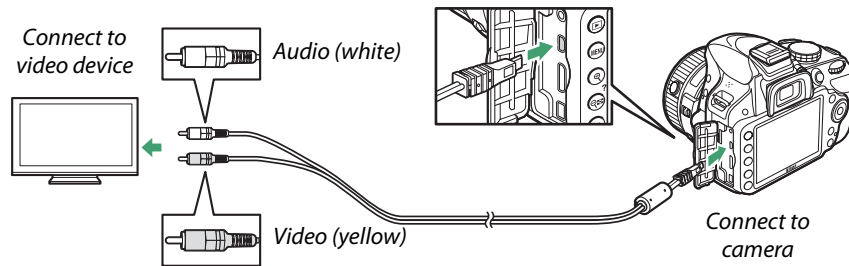

3 Tune the television to the video channel.

4 Turn the camera on and press the button.

During playback, images will be displayed on the television screen. Note that the edges of images may not be displayed.

Video Mode

If no image is displayed, check that camera is correctly connected and that the option selected for **Video mode** (□ 136) matches the video standard used in the TV.

Television Playback

Use of an EH-5b AC adapter and EP-5A power connector (available separately) is recommended for extended playback.

High-Definition Devices

The camera can be connected to HDMI devices using a type C mini-pin HDMI cable (available separately from third-party suppliers).

1 Turn the camera off.

Always turn the camera off before connecting or disconnecting an HDMI cable.

2 Connect the HDMI cable as shown.

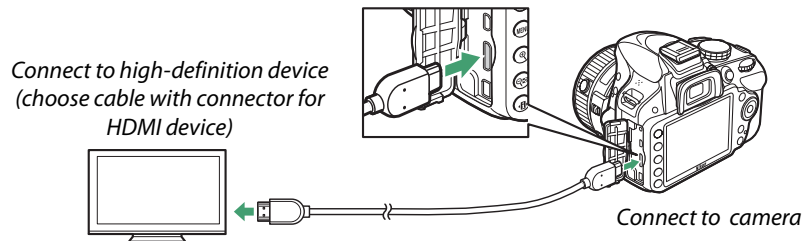

3 Tune the device to the HDMI channel.

4 Turn the camera on and press the button.

During playback, images will be displayed on the high-definition television or video device. Note that the edges of images may not be displayed.



Close the Connector Cover

Close the connector cover when the connectors are not in use. Foreign matter in the connectors can interfere with data transfer.

Audio

When a movie with sound recorded in stereo using an optional ME-1 stereo microphone (☎ 91, 177) is viewed on a television connected to the camera via an A/V cable, the audio output is monaural. HDMI connections support stereo output. Volume can be adjusted using television controls; the camera controls can not be used.

■ ■ HDMI Options

The **HDMI** option in the setup menu controls output resolution and can be used to enable the camera for remote control from devices that support HDMI-CEC (**H**igh-**D**efinition **M**ultimedia **I**nterface–**C**onsumer **E**lectronics **C**ontrol, a standard that allows HDMI devices to be used to control peripherals to which they are connected).

Output Resolution

Choose the format for images output to the HDMI device. If **Auto** is selected, the camera will automatically select the appropriate format. Regardless of the option selected, **Auto** will be used for movie recording and playback.

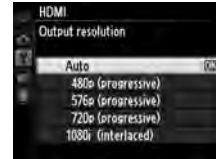

Device Control

If **On** is selected for **HDMI > Device control** in the setup menu when the camera is connected to a television that supports HDMI-CEC and both the camera and television are on, the display shown at right will appear on the television and the television remote can be used in place of the camera multi selector and  button during full-frame playback and slide shows. If **Off** is selected, the television remote can not be used to control the camera.



HDMI-CEC Devices

When the camera is connected to an HDMI-CEC device,  will appear in the viewfinder in place of the number of exposures remaining.

Device Control

See the television manual for details.

HDMI and Live View

HDMI displays connected via an HDMI cable can be used for live view and movie recording (□ 86, 90). During movie recording and playback, HDMI output is adjusted according to the option selected for **Movie settings > Frame size/frame rate** in the shooting menu (□ 90). Note that some devices may not support the selected setting; in this case, select **1080i (interlaced)** for **HDMI > Output resolution** (□ 124). Movies may be output at a frame size smaller than that selected for **Frame size/frame rate** (□ 90).

Menu Guide

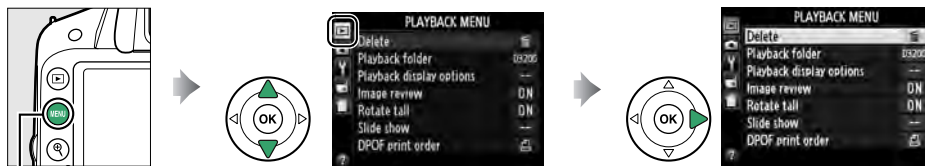

▶ The Playback Menu: *Managing Images*

To display the playback menu, press **MENU** and select the  (playback menu) tab.



MENU button

The playback menu contains the following options:

Option	Default		Option	Default	
Delete	—	107	Rotate tall	On	126
Playback folder	Current	125	Slide show	—	109
Playback display options	—	126	Image type	Still images and movies	
Additional photo info	—		Frame interval	2 s	
Transition effects	Slide in		Transition effects	Zoom/fade	
Image review	On	126	DPOF print order	—	120

Playback Folder

MENU button →  playback menu

Choose a folder for playback:

Option	Description
Current	Only photos in the folder currently selected for Storage folder in the setup menu ( 146) are displayed during playback. This option is selected automatically when a photo is taken. If a memory card is inserted and this option selected before photos have been taken, a message stating that the folder contains no images may be displayed during playback. Select All to begin playback.
All	Pictures in all folders will be visible during playback.

Playback Display Options

MENU button →  playback menu

Choose the information available in the playback photo information display ( 98) and the transition between frames during playback.

- **Additional photo info:** Press ▲ or ▼ to highlight an option, then press ► to select the option for the photo information display. A appears next to selected items; to deselect, highlight and press ►. To return to the playback menu, highlight **Done** and press .
- **Transition effects:** Choose from **Slide in** (each frame is pushed out of the display by the following frame), **Zoom/fade** (frames fade into one another with a zoom effect), and **None** (no transition between frames).

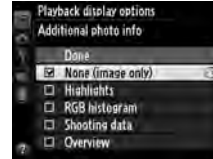



Image Review

MENU button →  playback menu

Choose whether pictures are automatically displayed in the monitor immediately after shooting. If **Off** is selected, pictures can only be displayed by pressing the  button.



Rotate Tall

MENU button →  playback menu

Choose whether to rotate “tall” (portrait-orientation) pictures for display during playback. Note that because the camera itself is already in the appropriate orientation during shooting, images are not rotated automatically during image review.



Option	Description
On	“Tall” (portrait-orientation) pictures are automatically rotated for display in the camera monitor. Pictures taken with Off selected for Auto image rotation ( 138) will be displayed in “wide” (landscape) orientation.
Off	“Tall” (portrait-orientation) pictures are displayed in “wide” (landscape) orientation.





The Shooting Menu: *Shooting Options*

To display the shooting menu, press **MENU** and select the  (shooting menu) tab.



MENU button

The shooting menu contains the following options:

Option	Default		Option	Default		
Reset shooting menu	—	128	AF-area mode			
Set Picture Control	Standard	76	Viewfinder	 Single-point AF	38	
Image quality	JPEG normal	44		 Dynamic-area AF		
Image size	Large	46	Other modes	Auto-area AF		
White balance	Auto	69	Live view/ movie	 Face-priority AF	82	
Fluorescent	Cool-white fluorescent	70		 P, S, A, M		Wide-area AF
ISO sensitivity settings				 Normal-area AF		
ISO sensitivity	P, S, A, M	100	Built-in AF-assist illuminator	On	131	
	Other modes	Auto	Metering	Matrix metering	60	
Auto ISO sensitivity control	Off	129	Movie settings			
Active D-Lighting	On	67	Frame size/frame rate*	—	90	
Auto distortion control	Off	130	Movie quality	High quality		
Color space	sRGB	130	Microphone	Auto sensitivity		
Noise reduction	On	131	Manual movie settings	Off		
			Flash cntrl for built-in flash	TTL	132	

* Default varies with country of purchase.

Note: Depending on camera settings, some items may be grayed out and unavailable. For information on the options available in each shooting mode, see page 187.



















Reset Shooting Menu

MENU button →  shooting menu

Select **Yes** to reset shooting menu settings.

Reset Shooting Options

Selecting **Yes** for **Reset shooting menu** also restores Picture Control settings to their default values (📖 77) and resets the following:

Option	Default	📖	Option	Default	📖
Release mode			Flash mode		
    	Single frame	31	   	Auto front-curtain sync	48
	Continuous			Auto slow sync	
Focus point *	Center	40	   	Front curtain sync	
Flexible program	Off	54	Exposure compensation	Off	63
 (🔘) button hold	Off	143	Flash compensation	Off	65
Focus mode					
Viewfinder	Auto-servo AF	35			
Live view/movie	Single-servo AF	81			

* Not displayed if  (Auto-area AF) is selected for **AF-area mode** > **Viewfinder**.



ISO Sensitivity Settings

MENU button → shooting menu

Adjust ISO sensitivity (□ 51).

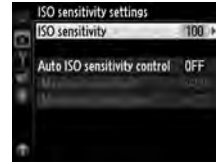

■ Auto ISO Sensitivity control

If **Off** is chosen for **Auto ISO sensitivity control** in **P**, **S**, **A**, and **M** modes, ISO sensitivity will remain fixed at the value selected by the user (□ 51). When **On** is chosen, ISO sensitivity will automatically be adjusted if optimal exposure can not be achieved at the value selected by the user (ISO sensitivity is adjusted appropriately when the flash is used). The maximum value for auto ISO sensitivity can be selected using the **Maximum sensitivity** option in the **Auto ISO sensitivity control** menu (choose lower values to prevent noise (randomly-spaced bright pixels, fog, or lines; the minimum value for auto ISO sensitivity is automatically set to ISO 100)). In modes **P** and **A**, sensitivity will only be adjusted if underexposure would result at the shutter speed selected for **Minimum shutter speed** ($1/2000$ – 1 s, or **Auto**; in modes **S** and **M**, sensitivity will be adjusted for optimal exposure at the shutter speed selected by the user). If **Auto** (available only with CPU lenses) is selected, the camera will choose the minimum shutter speed based on the focal length of the lens. Slower shutter speeds will be used only if optimum exposure can not be achieved at the ISO sensitivity value selected for **Maximum sensitivity**.

When **On** is selected, the viewfinder shows **ISO-AUTO** and the information display **ISO-A**. These indicators flash when sensitivity is altered from the value selected by the user.



✓ Auto ISO Sensitivity Control

Noise (randomly-spaced bright pixels, fog, or lines) is more likely at higher sensitivities. Use the **Noise reduction** option in the shooting menu to reduce noise (□ 131). Note that ISO sensitivity may be raised automatically when auto ISO sensitivity control is used in combination with slow sync flash modes (available with the built-in flash and the optional flash units listed on page 173), possibly preventing the camera from selecting slow shutter speeds.

Auto Distortion Control

MENU button →  shooting menu

Select **On** to reduce barrel distortion in photos taken with wide-angle lenses and to reduce pin-cushion distortion in photos taken with long lenses (note that the edges of the area visible in the viewfinder may be cropped out of the final photograph, and that the time needed to process photographs before recording begins may increase). This option does not apply to movies and is available only with type G and D lenses (PC, fisheye, and certain other lenses excluded); results are not guaranteed with other lenses.



Retouch: Distortion Control

For information creating copies of existing photographs with reduced barrel and pin-cushion distortion, see page 159.

Color Space

MENU button →  shooting menu

The color space determines the gamut of colors available for color reproduction. Choose **sRGB** for photographs that will be printed or used “as is,” with no further modification. **Adobe RGB** has a wider color gamut and is recommended for images that will be extensively processed or retouched after leaving the camera.



Color Space

Color spaces define the correspondence between colors and the numeric values that represent them in a digital image file. The sRGB color space is widely used, while the Adobe RGB color space is typically used in publishing and commercial printing. sRGB is recommended when taking photographs that will be printed without modification or viewed in applications that do not support color management, or when taking photographs that will be printed with ExifPrint, the direct printing option on some household printers, or kiosk printing or other commercial print services. Adobe RGB photographs can also be printed using these options, but colors will not be as vivid.

JPEG photographs taken in the Adobe RGB color space are DCF compliant; applications and printers that support DCF will select the correct color space automatically. If the application or device does not support DCF, select the appropriate color space manually. For more information, see the documentation provided with the application or device.

Nikon Software

ViewNX 2 (supplied) and Capture NX 2 (available separately) automatically select the correct color space when opening photographs created with this camera.



Noise Reduction

MENU button →  shooting menu

Select **On** to reduce noise (bright spots, randomly-spaced bright pixels, lines, or fog). Noise reduction takes effect at all ISO sensitivities, but is most noticeable at higher values. The time required for processing at shutter speeds slower than about 1 s or when the camera's internal temperature is elevated and ISO sensitivity is high roughly doubles; during processing, "⏏ nr" will flash in the viewfinder and photographs can not be taken. Noise reduction will not be performed if the camera is turned off before processing is complete.

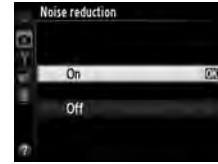

If **Off** is selected, noise reduction will only be performed at high ISO sensitivities; the amount of noise reduction is less than that performed when **On** is selected.



Built-in AF-assist Illuminator

MENU button →  shooting menu

Choose whether the built-in AF-assist illuminator lights to assist the focus operation when lighting is poor.

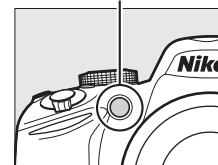
AF-assist illuminator



Option	Description
On	The AF-assist illuminator lights when lighting is poor (viewfinder photography only). AF-assist illumination is only available when both of the following conditions are met: <ol style="list-style-type: none"> AF-S is selected for focus mode (☐ 35) or single-servo autofocus is selected when the viewfinder is used in AF-A mode.  (Auto-area AF) is chosen for AF-area mode > Viewfinder (☐ 38, 39), or an option other than  (Auto-area AF) is chosen and the center focus point is selected.
Off	The AF-assist illuminator does not light to assist the focus operation. The camera may not be able to focus using autofocus when lighting is poor.



See Also

See page 37 for information on using the AF-assist illuminator. Information on the shooting modes in which AF-assist is available may be found on page 187. See page 171 for restrictions on the lenses that can be used with AF assist.

Flash Cntrl for Built-in Flash

MENU button →  shooting menu

Choose the flash mode for the built-in flash in **P**, **S**, **A**, and **M** modes.

Option	Description
 TTL	Flash output is adjusted automatically in response to shooting conditions.
 Manual	Choose a flash level between Full and 1/32 (1/32 of full power). At full power, the built-in flash has a Guide Number of 13/43 (m/ft, ISO 100, 20 °C/68 °F).

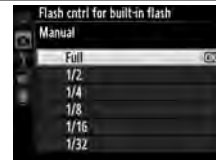

Manual

A  icon flashes in the viewfinder and information display when **Manual** is selected and the flash is raised.

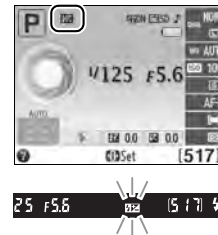

The SB-400

When an optional SB-400 flash unit is attached and turned on, **Flash cntrl for built-in flash** changes to **Optional flash**, allowing the flash control mode for the SB-400 to be selected from **TTL** and **Manual**.

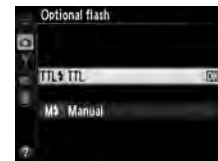

Flash Control

The following types of flash control are supported when a CPU lens is used in combination with the built-in flash (□ 47) or optional flash units (□ 172).

- **i-TTL Balanced Fill-Flash for Digital SLR:** Information from the 420-pixel RGB sensor is used to adjust flash output for a natural balance between the main subject and the background.
- **Standard i-TTL Fill-Flash for Digital SLR:** Flash output is adjusted for the main subject; the brightness of the background is not taken into account. Recommended for shots in which the main subject is emphasized at the expense of background details, or when exposure compensation is used.

Standard i-TTL flash control is used with spot metering or when selected with the optional flash unit. i-TTL balanced fill-flash for digital SLR is used in all other cases.



🔑 The Setup Menu: *Camera Setup*

To display the setup menu, press **MENU** and select the 🔑 (setup menu) tab.



MENU button

The setup menu contains the following options:

Option	Default	📖
Reset setup options	—	134
Format memory card	—	19
Monitor brightness	0	134
Info display format	Graphic; Background color: White	134
Auto info display	On	136
Clean image sensor		
Clean at startup/shutdown	Clean at startup & shutdown	180
Lock mirror up for cleaning ¹	—	182
Video mode ²	—	136
HDMI		
Output resolution	Auto	124
Device control	On	124
Flicker reduction	Auto	136
Time zone and date ²		
Daylight saving time	Off	137
Language ²	—	137
Image comment	—	138
Auto image rotation	On	138
Image Dust Off ref photo	—	139
Auto off timers	Normal	140
Self-timer		
Self-timer delay	10 s	141
Number of shots	1	141
Remote on duration	1 min	141
Beep	Low	141
Rangefinder	Off	142
File number sequence	Off	142
Buttons		
Assign Fn button	ISO sensitivity	143
Assign AE-L/AF-L button	AE/AF lock	143
Shutter-release button AE-L	Off	144
Slot empty release lock	Release locked	144
Print date	Off	144
Storage folder	—	146
GPS		
Standby timer	Enable	147
Use GPS to set camera clock	Yes	147
Eye-Fi upload ³	Enable	148
Firmware version	—	148

1 Not available when battery is low.

2 Default varies with country of purchase.

3 Only available when compatible Eye-Fi memory card is inserted (📖 148).

Note: Depending on camera settings, some items may be grayed out and unavailable.

Reset Setup Options

MENU button →  setup menu

Select **Yes** to reset setup menu all settings except **Video mode**, **Time zone and date**, **Language**, and **Storage folder** to the defaults listed above.

Monitor Brightness

MENU button →  setup menu

Press ▲ or ▼ to choose monitor brightness. Choose higher values for increased brightness, lower values for reduced brightness.



Info Display Format

MENU button →  setup menu

Choose from the following two formats for the information display (□ 5).



Classic (□ 135)



Graphic (□ 5)

- 1 Select a format.**
Highlight an option and press ►.



- 2 Select a background color.**
Highlight a background color and press .
Choose from blue, black, or orange (Classic) or white, black, or brown (Graphic).



The "Classic" display is shown below.

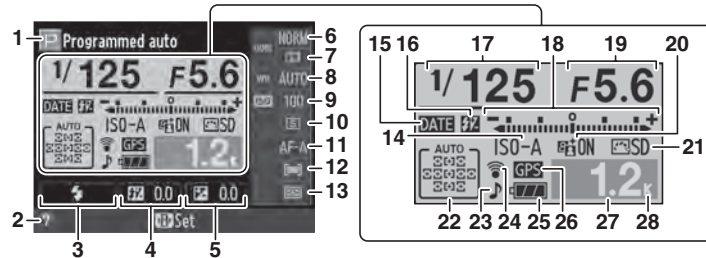

<p>1 Shooting mode <small>auto/</small> <small>Ⓢ</small> auto (flash off)22 Scene modes25 P, S, A, and M modes.....53</p> <p>2 Help icon..... 193</p> <p>3 Flash mode.....48</p> <p>4 Flash compensation65</p> <p>5 Exposure compensation63</p> <p>6 Image quality.....44</p> <p>7 Image size.....46</p> <p>8 White balance.....69</p> <p>9 ISO sensitivity 51</p> <p>10 Release mode31</p> <p>11 Focus mode..... 35, 81</p> <p>12 AF-area mode 38, 82</p>	<p>13 Metering..... 60</p> <p>14 Auto ISO sensitivity indicator129</p> <p>15 Print date indicator144</p> <p>16 Manual flash indicator132 Flash compensation indicator for optional flash units....175</p> <p>17 Shutter speed..... 55, 57</p> <p>18 Exposure indicator 57 Exposure compensation indicator 64</p> <p>19 Aperture (f-number)..... 56, 57</p> <p>20 Active D-Lighting 67</p> <p>21 Picture Control 76</p> <p>22 Auto-area AF indicator..... 38 3D-tracking indicator 38 Focus point 40</p>	<p>23 "Beep" indicator 141</p> <p>24 Eye-Fi connection indicator..... 148</p> <p>25 Battery indicator21</p> <p>26 GPS connection indicator..... 147</p> <p>27 Number of exposures remaining21 White balance recording indicator72</p> <p>28 "K" (appears when memory remains for over 1000 exposures).....21</p>
--	--	---

Rotating the Camera

When the camera is rotated 90°, shooting information rotates to match camera orientation.



Auto Info Display

MENU button →  setup menu

If **On** is selected, the information display will appear after the shutter-release button is pressed halfway; if image review (☐ 126) is off, it will also be displayed immediately after shooting. Choose **On** if you find yourself frequently referring to the information display during shooting. If **Off** is selected, the information display can be viewed by pressing the  button.

Video Mode

MENU button →  setup menu

When connecting the camera to a television or VCR, be sure the camera video mode matches the device video standard (NTSC or PAL).

Flicker Reduction

MENU button →  setup menu

Reduce flicker and banding when shooting under fluorescent or mercury-vapor lighting during live view (☐ 80) or movie recording (☐ 88). Choose **Auto** to allow the camera to automatically choose the correct frequency, or manually match the frequency to that of the local AC power supply.

Flicker Reduction

If **Auto** fails to produce the desired results and if you are unsure as to the frequency of the local power supply, test both options and choose the one that produces the best results. Flicker reduction may not produce the desired results with some subjects, in which case you should select mode **A** or **M** and choose a smaller aperture (higher f-number) before starting live view. Note that flicker reduction is not available when **On** is selected for **Movie settings** > **Manual movie settings** (☐ 91) in mode **M**.





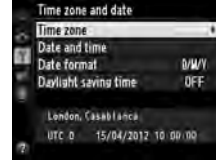

Time Zone and Date

MENU button →  setup menu

Change time zones, set the camera clock, choose the date display order, and turn daylight saving time on or off.

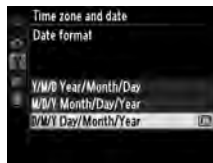

Option	Description	
Time zone	Choose a time zone. The camera clock is automatically set to the time in the new time zone.	
Date and time	Set the camera clock ( 16).	
Date format	Choose the order in which the day, month, and year are displayed.	
Daylight saving time	Turn daylight saving time on or off. The camera clock will automatically be advanced or set back one hour. The default setting is Off .	

Language



MENU button →  setup menu



Choose a language for camera menus and messages.

Image Comment

MENU button →  setup menu

Add a comment to new photographs as they are taken. Comments can be viewed as metadata in ViewNX 2 (supplied) or Capture NX 2 (available separately;  176). The comment is also visible on the shooting data page in the photo information display ( 100).

- **Done:** Save changes and return to the setup menu.
- **Input comment:** Input a comment as described on page 146. Comments can be up to 36 characters long.
- **Attach comment:** Select this option to attach the comment to all subsequent photographs. **Attach comment** can be turned on and off by highlighting it and pressing .



Auto Image Rotation

MENU button →  setup menu

Photographs taken while **On** is selected contain information on camera orientation, allowing them to be rotated automatically during playback or when viewed in ViewNX 2 or Capture NX 2 (available separately;  176). The following orientations are recorded:

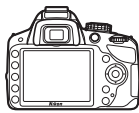

Landscape (wide) orientation



Camera rotated 90° clockwise



Camera rotated 90° counterclockwise

Camera orientation is not recorded when **Off** is selected. Choose this option when panning or taking photographs with the lens pointing up or down.



Rotate Tall

To automatically rotate “tall” (portrait-orientation) photographs for display during playback, select **On** for the **Rotate tall** option in the playback menu ( 126).

Image Dust Off Ref Photo

MENU button →  setup menu

Acquire reference data for the Image Dust Off option in Capture NX 2 (available separately; for more information, see the Capture NX 2 manual).

Image Dust off ref photo is available only when a CPU lens is mounted on the camera. A lens with a focal length of at least 50 mm is recommended. When using a zoom lens, zoom all the way in.

1 Choose a start option.

Highlight one of the following options and press . To exit without acquiring image dust off data, press MENU.



- **Start:** The message shown at right will be displayed and “rEF” will appear in the viewfinder.
- **Clean sensor and then start:** Select this option to clean the image sensor before starting. The message shown at right will be displayed and “rEF” will appear in the viewfinder when cleaning is complete.

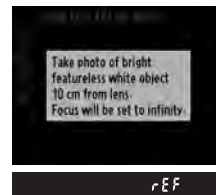

Image Sensor Cleaning

Image Dust Off reference data recorded before image sensor cleaning is performed can not be used with photographs taken after image sensor cleaning is performed. Select **Clean sensor and then start** only if the Image Dust Off reference data will not be used with existing photographs.

2 Frame a featureless white object in the viewfinder.

With the lens about ten centimeters (four inches) from a well-lit, featureless white object, frame the object so that it fills the viewfinder and then press the shutter-release button halfway.



In autofocus mode, focus will automatically be set to infinity; in manual focus mode, set focus to infinity manually.

3 Acquire Image Dust Off reference data.

Press the shutter-release button the rest of the way down to acquire Image Dust Off reference data. The monitor turns off when the shutter-release button is pressed. Note that noise reduction will be performed if the subject is poorly lit, increasing recording times.

If the reference object is too bright or too dark, the camera may be unable to acquire Image Dust Off reference data and the message shown at right will be displayed. Choose another reference object and repeat the process from step 1.

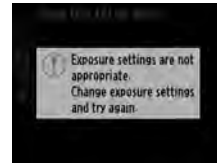

✔ Image Dust Off Reference Data

The same reference data can be used for photographs taken with different lenses or at different apertures. Reference images can not be viewed using computer imaging software. A grid pattern is displayed when reference images are viewed on the camera.



Auto off Timers

MENU button → setup menu

This option determines how long the monitor remains on if no operations are performed during menu display and playback (**Playback/menus**), while photographs are displayed in the monitor after shooting (**Image review**), and during live view (**Live view**), and how long the standby timer, viewfinder, and information display remain on when no operations are performed (**Standby timer**). Choose shorter auto-off delays to reduce the drain on the battery.

Option	Description (all times are approximate)				
SHORT Short NORM Normal LONG Long	Auto off timers are set to the following values:				
		Playback/menus	Image review	Live view	Standby timer
	Short	20 s	4 s	5 min.	4 s
	Normal	1 min.	4 s	10 min.	8 s
Long	1 min.	20 s	20 min.	1 min.	
Custom	Choose separate delays for Playback/menus , Image review , Live view , and Standby timer . When settings are complete, highlight Done and press .				

✔ Auto off Timers

The monitor and viewfinder will not turn off automatically when the camera is connected to a computer or printer via USB.



Self-Timer

MENU button →  setup menu

Choose the length of the shutter release delay and the number of shots taken (□ 33).



- **Self-timer delay:** Choose the length of the shutter-release delay.

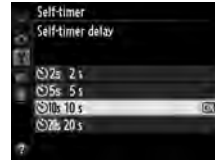

- **Number of shots:** Press ▲ and ▼ to choose the number of shots taken each time the shutter-release button is pressed (from 1 to 9; if a value other than 1 is selected, shots will be taken at 4 s intervals).



Remote on Duration

MENU button →  setup menu

Choose how long the camera will remain before cancelling the currently selected remote control release mode and restoring the previously selected release mode (□ 31). Choose shorter times for longer battery life.

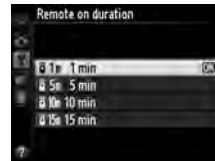



Beep

MENU button →  setup menu

Choose the pitch (**High** or **Low**) of the beep that sounds when the camera focuses using single-servo AF (**AF-S** or when single-servo AF is selected for **AF-A**; □ 35), when focus locks in live view, while the release timer is counting down in self-timer and delayed remote release modes (□ 33), and when a photograph is taken in quick-response remote mode (□ 33). Select **Off** to prevent the beep from sounding. Note that a beep will not sound during movie recording (□ 88), or in quiet-shutter release mode (mode ; □ 31).









The current setting is shown in the information display:  is displayed when the beep is on,  when it is off.



Rangefinder

MENU button →  setup menu

Choose **On** to use the exposure indicator to determine whether the camera is correctly focused in manual focus mode (☞ 42; note that this function is not available in shooting mode **M**, when the exposure indicator instead shows whether the subject is correctly exposed).

Indicator	Description	Indicator	Description
	Camera in focus.		Focus point is slightly behind subject.
	Focus point is slightly in front of subject.		Focus point is well behind subject.
	Focus point is well in front of subject.		Camera can not determine correct focus.

Using the Electronic Rangefinder

The electronic rangefinder requires a lens with a maximum aperture of f/5.6 or faster. The desired results may not be achieved in situations in which the camera would be unable to focus using autofocus (☞ 36). The electronic rangefinder is not available during live view.

File Number Sequence

MENU button →  setup menu

When a photograph is taken, the camera names the file by adding one to the last file number used. This option controls whether file numbering continues from the last number used when a new folder is created, the memory card is formatted, or a new memory card is inserted in the camera.



Option	Description
On	When a new folder is created, the memory card formatted, or a new memory card inserted in the camera, file numbering continues from the last number used or from the largest file number in the current folder, whichever is higher. If a photograph is taken when the current folder contains a photograph numbered 9999, a new folder will be created automatically and file numbering will begin again from 0001.
Off	File numbering is reset to 0001 when a new folder is created, the memory card is formatted, or a new memory card is inserted in the camera. Note that a new folder is created automatically if a photograph is taken when the current folder contains 999 photographs.
RESET Reset	Resets the file numbering for On to 0001 and creates a new folder with the next photograph taken.

✓ File Number Sequence

If the current folder is numbered 999 and contains either 999 photographs or a photograph numbered 9999, the shutter-release button will be disabled and no further photographs can be taken. Choose **Reset** for **File number sequence** and then either format the current memory card or insert a new memory card.

Buttons

MENU button →  setup menu

Choose the roles played by the **Fn** and $\overset{AE-L}{AF-L}$ (**O-n**) buttons.

Assign Fn button

Choose the role played by the **Fn** button (□ 8).

Option	Description
QUAL Image quality/size *	Press the Fn button and rotate the command dial to select image quality and size (□ 44).
ISO ISO sensitivity *	Press the Fn button and rotate the command dial to select ISO sensitivity (□ 51).
WB White balance *	Press the Fn button and rotate the command dial to select white balance (P , S , A , and M modes only; □ 69).
 Active D-Lighting	Press the Fn button and rotate the command dial to select an Active D-Lighting option (P , S , A , and M modes only; □ 67).

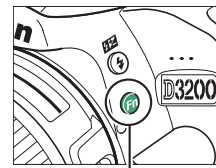





Fn button

* The item currently selected is shown by a white-on-black icon in the information display.

Assign AE-L/AF-L button

Choose the role played by the $\overset{AE-L}{AF-L}$ (**O-n**) button.

Option	Description
 AE/AF lock	Focus and exposure lock while the $\overset{AE-L}{AF-L}$ (O-n) button is pressed.
 AE lock only	Exposure locks while the $\overset{AE-L}{AF-L}$ (O-n) button is pressed.
 AF lock only	Focus locks while the $\overset{AE-L}{AF-L}$ (O-n) button is pressed.
 AE lock (Hold)	Exposure locks when the $\overset{AE-L}{AF-L}$ (O-n) button is pressed, and remains locked until the button is pressed a second time or the standby timer expires.
 AF-ON	The $\overset{AE-L}{AF-L}$ (O-n) button initiates autofocus. The shutter-release button can not be used to focus except when AF-F is selected in live view or during movie recording.

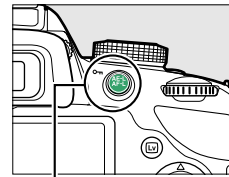

$\overset{AE-L}{AF-L}$ (**O-n**) button



■ ■ Shutter-release button AE-L

At the default setting of **Off**, exposure only locks when the AE-L (AE-L) button is pressed. If **On** is selected, exposure will also lock when the shutter-release button is pressed halfway.

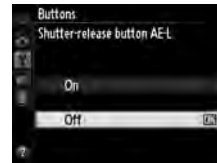

Slot Empty Release Lock

MENU button → Y setup menu

If **Release locked** is selected, the shutter-release button is only enabled when a memory card is inserted in the camera. Selecting **Enable release** allows the shutter to be released when no memory card is inserted, although no pictures will be recorded (they will however be displayed in the monitor in demo mode).

Print Date

MENU button → Y setup menu

Choose the date information imprinted on photographs as they are taken.

Option	Description
Off	The time and date do not appear on photographs.
DATE Date	The date or date and time are imprinted on photographs taken while this option is in effect. 15.04.2012
DATE Date and time	15.04.2012 10:02
 Date counter	New photos are imprinted with a time stamp showing the number of days between the date of shooting and a selected date (145).

At settings other than **Off**, the selected option is indicated by a **DATE** icon in the information display.



Print Date

The date is recorded in the order selected in the **Time zone and date** menu (137). The date does not appear on NEF (RAW) or NEF (RAW)+JPEG images and can not be added to or removed from existing photos. To print the date of recording on photographs taken with date imprint off, select **Time stamp** in the PictBridge menu (116), or select **Print date** in the **DPOF print order** menu to print the date of recording on all pictures in the current DPOF print order (121).

■ ■ Date Counter

Pictures taken while this option is in effect are imprinted with the number of days remaining until a future date or the number of days elapsed since a past date. Use it to track the growth of a child or count down the days until a birthday or wedding.

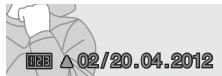

Future date (two days remaining)



Past date (two days elapsed)

Up to three separate dates can be stored in slots 1, 2, and 3. The first time you use the date counter, you will be prompted to select a date for slot 1; enter a date using the multi selector and press **OK**. To change the date or store additional dates, highlight a slot, press **▶**, and enter the date. To use the stored date, highlight the slot and press **OK**.

To choose a date counter format, highlight **Display options** and press **▶** to display the menu shown at right. Highlight an option and press **OK**. Highlight **Done** in the date counter menu and press **OK** when settings are complete.

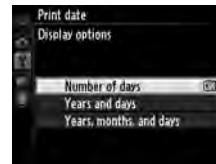
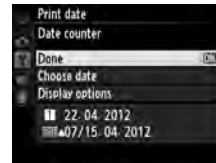

Storage Folder

MENU button →  setup menu



Create, rename, or delete folders, or choose the folder in which subsequent photographs will be stored.

- **Select folder:** Choose the folder in which subsequent photographs will be stored.



- **New:** Create a new folder and name it as described below. Folder names can be up to five characters long.
- **Rename:** Select a folder from the list and rename it as described below.
- **Delete:** Delete all empty folders on the memory card.

■ Naming and Renaming Folders

Folder names can be up to five characters long. To move the cursor in the name area, rotate the command dial. To enter a new letter at the current cursor position, use the multi selector to highlight the desired character in the keyboard area and press . To delete the character at the current cursor position, press the  button. Press the  button to save changes and return to the setup menu, or press MENU to exit without creating a new folder or changing the folder name.

Keyboard area



Name area

Folder Names

On the memory card, folder names are preceded by a three-digit folder number assigned automatically by the camera (e.g., 100D3200). Each folder can contain up to 999 photographs. During shooting, pictures are stored in the highest-numbered folder with the selected name. If a photograph is taken when the current folder is full or contains a photograph numbered 9999, the camera will create a new folder by adding one to the current folder number (e.g., 101D3200). The camera treats folders with the same name but different folder numbers as the same folder. For example, if the folder NIKON is selected for **Storage folder**, photographs in all folders named NIKON (100NIKON, 101NIKON, 102NIKON, etc.) will be visible when **Current** is selected for **Playback folder** ( 125). Renaming changes all folders with the same name but leaves the folder numbers intact. Selecting **Delete** deletes empty numbered folders but leaves other folders with the same name intact.



GPS

MENU button →  setup menu

This item is used to adjust settings for optional GP-1 GPS units. The GP-1 can be connected to the camera's accessory terminal (□ 177) using the cable supplied with the GP-1, allowing information on the camera's current position to be recorded when photographs are taken (turn the camera off before connecting the GP-1; for more information, see the GP-1 manual).

The **GPS** menu contains the options listed below.

- **Standby timer:** Choose whether the exposure meters turn off automatically when the GP-1 is attached.

Option	Description
Enable	Exposure meters turn off automatically if no operations are performed for the time selected for Auto off timers > Standby timer in the setup menu (□ 140; to allow the camera time to acquire GPS data, the delay is extended by up to one minute after exposure meters are activated or the camera is turned on). This reduces the drain on the battery.
Disable	Exposure meters do not turn off while the GP-1 is connected.

- **Position:** This item is only available if the GP-1 is connected, when it displays the current latitude, longitude, altitude, and Coordinated Universal Time (UTC) as reported by the GP-1.
- **Use GPS to set camera clock:** Select **Yes** to synchronize the camera clock with the time reported by the GPS device.

Coordinated Universal Time (UTC)

UTC data is provided by the GPS device and is independent of the camera clock.

The GPS Icon

Connection status is shown by the **GPS** icon:

- **GPS (static):** Camera has established communication with GP-1. Photo information for pictures taken while this icon is displayed include an additional page of GPS data (□ 101).
- **GPS (flashing):** The GP-1 is searching for a signal. Pictures taken while the icon is flashing do not include GPS data.
- **No icon:** No new GPS data have been received from the GP-1 for at least two seconds. Pictures taken when the **GPS** icon is not displayed do not include GPS data.







Eye-Fi Upload

MENU button →  setup menu

This option is displayed only when an Eye-Fi memory card (available separately from third-party suppliers) is inserted in the camera. Choose **Enable** to upload photographs to a preselected destination. Note that pictures will not be uploaded if signal strength is insufficient.

Observe all local laws concerning wireless devices and choose **Disable** where wireless devices are prohibited.

When an Eye-Fi card is inserted, its status is indicated by an icon in the information display:

- : Eye-Fi upload disabled.
- : Eye-Fi upload enabled but no pictures available for upload.
-  (static): Eye-Fi upload enabled; waiting to begin upload.
-  (animated): Eye-Fi upload enabled; uploading data.
- : Error.



Eye-Fi Cards

Eye-Fi cards may emit wireless signals when **Disable** is selected. If a warning is displayed in the monitor ( 194), turn the camera off and remove the card.

See the manual provided with the Eye-Fi card, and direct any inquiries to the manufacturer. The camera can be used to turn Eye-Fi cards on and off, but may not support other Eye-Fi functions.

Supported Eye-Fi Cards

As of December 2011, the camera supports 8 GB SDHC Pro X2 Eye-Fi cards. Some cards may not be available in some countries or regions; consult the manufacturer for more information. Eye-Fi cards are for use only in the country of purchase. Be sure the Eye-Fi card firmware has been updated to the latest version.

Using Eye-Fi Cards in Ad Hoc Mode

Additional time may be required when connecting using Eye-Fi cards that support ad hoc mode. Select longer values for **Auto off timers** > **Standby timer** in the setup menu ( 140).



Firmware Version

MENU button →  setup menu

View the current camera firmware version.





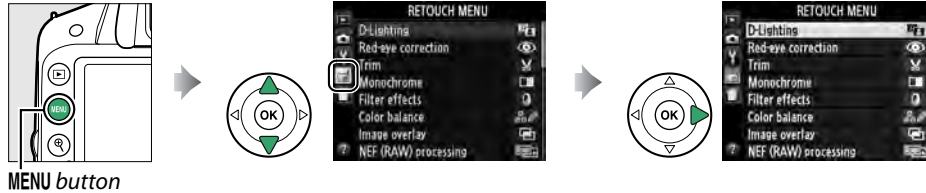















The Retouch Menu: Creating Retouched Copies

To display the retouch menu, press **MENU** and select the  (retouch menu) tab.



MENU button

The retouch menu is used to create trimmed or retouched copies of the photographs on the memory card, and is only available when a memory card containing photographs is inserted in the camera.

Option		Option		Option	
 D-Lighting	151	 NEF (RAW) processing	157	 Color sketch	160
 Red-eye correction	151	 Resize	158	 Perspective control	161
 Trim	152	 Quick retouch	159	 Miniature effect	162
 Monochrome	152	 Straighten	159	 Selective color	163
 Filter effects	153	 Distortion control	159	 Edit movie	93
 Color balance	154	 Fisheye	160	 Side-by-side comparison ²	165
 Image overlay ¹	155	 Color outline	160		

1 Can only be selected by pressing MENU button and selecting  tab.

2 Available only if  button is pressed in full-frame playback when a retouched image or original is displayed.

Retouching Copies

Most options can be applied to copies created using other retouch options, although with the exceptions of **Image overlay** and **Edit movie > Choose start/end point** each option can be applied only once (note that multiple edits may result in loss of detail). Options that can not be applied to the current image are grayed out and unavailable.

Image Quality

Except in the case of copies created with **Trim**, **Image overlay**, **NEF (RAW) processing**, and **Resize**, copies created from JPEG images are the same size and quality as the original, while copies created from NEF (RAW) photos are saved as large fine-quality JPEG images. Time stamps added with **Print date** ( 144) may however be cropped out or illegible depending on the retouch options used.



Creating Retouched Copies

To create a retouched copy:

- 1 Display retouch options.**
Highlight the desired item in the retouch menu and press **▶**.

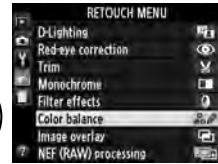

- 2 Select a picture.**
Highlight a picture and press **OK**.

Retouch
The camera may not be able to display or retouch images created with other devices. If the image was recorded at an image quality setting of **NEF (RAW) + JPEG fine** (□ 44), retouch options apply only to the JPEG copy (**Image overlay** and **NEF (RAW) processing** excepted).



- 3 Select retouch options.**
For more information, see the section for the selected item. To exit without creating a retouched copy, press **MENU**.



- 4 Create a retouched copy.**
Press **OK** to create a retouched copy. Except in the photo information "image only" page (□ 98), retouched copies are indicated by a  icon.



Creating Retouched Copies During Playback
Retouched copies can also be created during playback.



Display picture full frame and press **OK**.

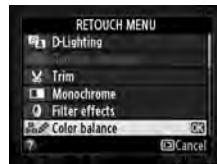

Highlight an option and press **OK**.



Create retouched copy.

D-Lighting

MENU button → retouch menu

D-Lighting brightens shadows, making it ideal for dark or backlit photographs.



Before

After

Press ▲ or ▼ to choose the amount of correction performed. The effect can be previewed in the edit display. Press to copy the photograph.

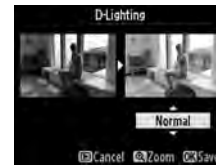

Red-Eye Correction

MENU button → retouch menu

This option is used to correct “red-eye” caused by the flash, and is available only with photographs taken using the flash. The photograph selected for red-eye correction can be previewed in the edit display. Confirm the effects of red-eye correction and create a copy as described in the following table. Note that red-eye correction may not always produce the expected results and may in very rare circumstances be applied to portions of the image that are not affected by red-eye; check the preview thoroughly before proceeding.

To	Use	Description
Zoom in		Press button to zoom in, (?) button to zoom out. While photo is zoomed in, use multi selector to view areas of image not visible in monitor. Keep multi selector pressed to scroll rapidly to other areas of frame. Navigation window is displayed when zoom buttons or multi selector is pressed; area currently visible in monitor is indicated by yellow border. Press to cancel zoom.
Zoom out	(?)	
View other areas of image		If the camera detects red-eye in the selected photograph, a copy will be created that has been processed to reduce its effects. No copy will be created if the camera is unable to detect red-eye.
Cancel zoom		
Create copy		



Trim

MENU button → retouch menu

Create a cropped copy of the selected photograph. The selected photograph is displayed with the selected crop shown in yellow; create a cropped copy as described in the following table.



To	Use	Description
Increase size of crop		Press the button to increase the size of the crop.
Reduce size of crop		Press the button to reduce the size of the crop.
Change crop aspect ratio		Rotate the command dial to switch between aspect ratios of 3 : 2, 4 : 3, 5 : 4, 1 : 1, and 16 : 9.
Move crop		Use multi selector to position the crop.
Create copy		Save the current crop as a separate file.

Trim: Image Quality and Size

Copies created from NEF (RAW) or NEF (RAW) + JPEG photos have an image quality of JPEG fine (□ 44); cropped copies created from JPEG photos have the same image quality as the original. The size of the copy varies with crop size and aspect ratio and appears at upper left in the crop display.



Viewing Cropped Copies

Playback zoom may not be available when cropped copies are displayed.

Monochrome

MENU button → retouch menu

Copy photographs in **Black-and-white**, **Sepia**, or **Cyanotype** (blue and white monochrome).



Selecting **Sepia** or **Cyanotype** displays a preview of the selected image; press ▲ to increase color saturation, ▼ to decrease. Press to create a monochrome copy.

Increase saturation

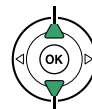

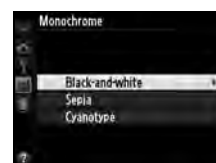

Decrease saturation



Filter Effects

MENU button →  retouch menu

Choose from the following filter effects. After adjusting filter effects as described below, press **OK** to copy the photograph.

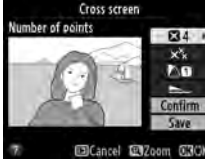
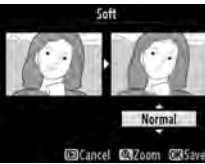
Option	Description	
Skylight	Creates the effect of a skylight filter, making the picture less blue. The effect can be previewed in the monitor as shown at right.	
Warm filter	Creates a copy with warm tone filter effects, giving the copy a “warm” red cast. The effect can be previewed in the monitor.	
Red intensifier	Intensify reds (Red intensifier), greens (Green intensifier), or blues (Blue intensifier). Press ▲ to increase the effect, ▼ to decrease.	
Green intensifier		
Blue intensifier		
Cross screen	<p>Add starburst effects to light sources.</p> <ul style="list-style-type: none"> • Number of points: Choose from four, six, or eight. • Filter amount: Choose the brightness of the light sources affected. • Filter angle: Choose the angle of the points. • Length of points: Choose the length of points. • Confirm: Preview the effects of the filter as shown at right. Press Q to preview the copy full frame. • Save: Create a retouched copy. 	
Soft	Add a soft filter effect. Press ▲ or ▼ to choose the filter strength.	



Color Balance

MENU button →  retouch menu

Use the multi selector to create a copy with modified color balance as shown below. The effect is displayed in the monitor together with red, green, and blue histograms (📖 99) giving the distribution of tones in the copy.

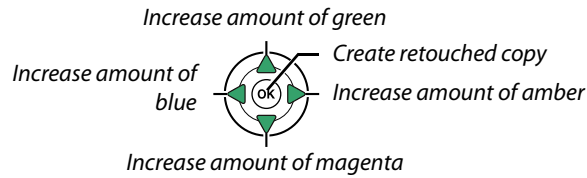

Zoom





To zoom in on the image displayed in the monitor, press the  button. The histogram will be updated to show data only for the portion of the image displayed in the monitor. While the image is zoomed in, press the  () button to toggle back and forth between color balance and zoom. When zoom is selected, you can zoom in and out with the  and  (?) buttons and scroll the image with the multi selector.



Image Overlay

MENU button →  retouch menu

Image overlay combines two existing NEF (RAW) photographs to create a single picture that is saved separately from the originals; the results, which make use of RAW data from the camera image sensor, are noticeably better than overlays created in an imaging application. The new picture is saved at current image quality and size settings; before creating an overlay, set image quality and size (☐ 44, 46; all options are available). To create an NEF (RAW) copy, choose an image quality of **NEF (RAW)**.



1 Select Image overlay.

Highlight **Image overlay** in the retouch menu and press ►.

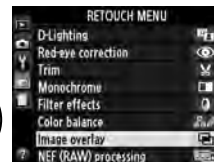

The dialog shown at right will be displayed, with **Image 1** highlighted; press **OK** to display a list of the NEF (RAW) pictures created with this camera.



2 Select the first image.

Use the multi selector to highlight the first photograph in the overlay. To view the highlighted photograph full frame, press and hold the **Q** button. Press **OK** to select the highlighted photograph and return to the preview display.



3 Select the second image.

The selected image will appear as **Image 1**. Highlight **Image 2** and press **OK**, then select the second photo as described in Step 2.

4 Adjust gain.

Highlight **Image 1** or **Image 2** and optimize exposure for the overlay by pressing **▲** or **▼** to select gain from values between 0.1 and 2.0. Repeat for the second image. The default value is 1.0; select 0.5 to halve gain or 2.0 to double it. The effects of gain are visible in the **Preview** column.



5 Preview the overlay.

Press **◀** or **▶** to place the cursor in the **Preview** column and press **▲** or **▼** to highlight **Overlay**. Press **OK** to preview the overlay as shown at right (to save the overlay without displaying a preview, select **Save**). To return to Step 4 and select new photos or adjust gain, press **ⓧ** (?).



6 Save the overlay.

Press **OK** while the preview is displayed to save the overlay. After an overlay is created, the resulting image will be displayed full-frame in the monitor.



Image Overlay

The overlay has the same photo info (including date of recording, metering, shutter speed, aperture, shooting mode, exposure compensation, focal length, and image orientation) and values for white balance and Picture Control as the photograph selected for **Image 1**.



NEF (RAW) Processing

MENU button → retouch menu

Create JPEG copies of NEF (RAW) photographs.

1 Select NEF (RAW) processing.

Highlight **NEF (RAW) processing** in the retouch menu and press to display a picture selection dialog listing only NEF (RAW) images created with this camera.

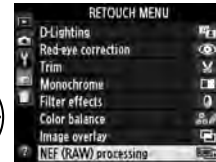

2 Select a photograph.

Use the multi selector to highlight a photograph (to view the highlighted photograph full frame, press and hold the button). Press to select the highlighted photograph and proceed to the next step.



3 Adjust NEF (RAW) processing settings.

Adjust the settings listed below. Note that white balance is not available with pictures created with image overlay, and that exposure compensation can only be set to values between -2 and $+2$ EV.

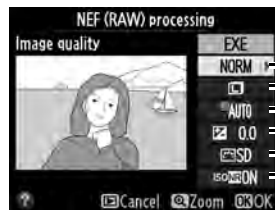

- Image quality (44)
- Image size (46)
- White balance (69)
- Exposure compensation (63)
- Picture Control (76)
- High ISO NR (131)

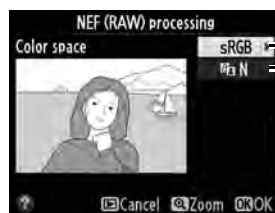

- Color space (130)
- D-Lighting (151)

4 Copy the photograph.

Highlight **EXE** and press to create a JPEG copy of the selected photograph. The resulting image will be displayed full-frame in the monitor. To exit without copying the photograph, press the **MENU** button.



Resize

MENU button →  retouch menu

Create small copies of selected photographs.

1 Select Resize.

To resize selected images, press MENU to display the menus and select **Resize** in the retouch menu.



2 Choose a size.

Highlight **Choose size** and press ►.



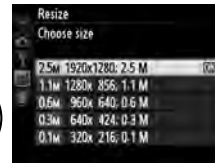

The options shown at right will be displayed; highlight an option and press **OK**.



3 Choose pictures.

Highlight **Select image** and press ►.



Highlight pictures using the multi selector and press the  (?) button to select or deselect (to view the highlighted picture full screen, press and hold the  button). Selected pictures are marked by a  icon. Press **OK** when the selection is complete.



4 Save the resized copies.

A confirmation dialog will be displayed. Highlight **Yes** and press **OK** to save the resized copies.



Viewing Resized Copies

Playback zoom may not be available when resized copies are displayed.

Image Quality

Copies created from NEF (RAW) or NEF (RAW) + JPEG photos have an image quality (☐ 44) of JPEG fine; copies created from JPEG photos have the same image quality as the original.

Quick Retouch

MENU button →  retouch menu

Create copies with enhanced saturation and contrast. D-Lighting is applied as required to brighten dark or backlit subjects.

Press ▲ or ▼ to choose the amount of enhancement. The effect can be previewed in the edit display. Press Ⓞ to copy the photograph.

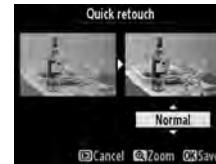

Straighten

MENU button →  retouch menu

Create a straightened copy of the selected image. Press ► to rotate the image clockwise by up to five degrees in increments of approximately 0.25 degrees, ◀ to rotate it counterclockwise (the effect can be previewed in the edit display; note that edges of the image will be trimmed to create a square copy). Press Ⓞ to copy the photograph, or press ▢ to exit to playback without creating a copy.



Distortion Control

MENU button →  retouch menu

Create copies with reduced peripheral distortion. Select **Auto** to let the camera correct distortion automatically and then make fine adjustments using the multi selector, or select **Manual** to reduce distortion manually (note that **Auto** is not available with photos taken using auto distortion control; see page 130). Press ► to reduce barrel distortion, ◀ to reduce pin-cushion distortion (the effect can be previewed in the edit display; note that greater amounts of distortion control result in more of the edges being cropped out). Press Ⓞ to copy the photograph, or press ▢ to exit to playback without creating a copy.



Auto

Auto is for use only with pictures taken with type G and D lenses (PC, fisheye, and certain other lenses excluded). Results are not guaranteed with other lenses.

Fisheye

MENU button →  retouch menu

Create copies that appear to have been taken with a fisheye lens. Press **▶** to increase the effect (this also increases the amount that will be cropped out at the edges of the image), **◀** to reduce it. The effect can be previewed in the edit display. Press **Ⓚ** to copy the photograph, or press **▶** to exit to playback without creating a copy.



Color Outline

MENU button →  retouch menu

Create an outline copy of a photograph to use as a base for painting. The effect can be previewed in the edit display. Press **Ⓚ** to copy the photograph.



Before

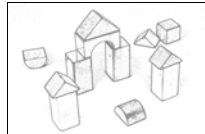

After



Color Sketch



MENU button →  retouch menu

Create a copy of a photograph that resembles a sketch made with colored pencils. Press **▲** or **▼** to highlight **Vividness** or **Outlines** and press **◀** or **▶** to change. Vividness can be increased to make colors more saturated, or decreased for a washed-out, monochromatic effect, while outlines can be made thicker or thinner. Thicker outlines make colors more saturated. The results can be previewed in the edit display. Press **Ⓚ** to copy the photograph, or press **▶** to exit to playback without creating a copy.



Perspective Control

MENU button →  retouch menu

Create copies that reduce the effects of perspective taken from the base of a tall object. Use the multi selector to adjust perspective (note that greater amounts of perspective control result in more of the edges being cropped out). The results can be previewed in the edit display. Press  to copy the photograph, or press  to exit to playback without creating a copy.

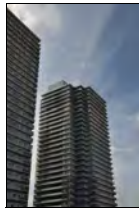

Before











After



Miniature Effect

MENU button →  retouch menu

Create a copy that appears to be a photo of a diorama. Works best with photos taken from a high vantage point. The area that will be in focus in the copy is indicated by a yellow frame.

To	Press	Description
Choose orientation		Press  (?) to choose orientation of area that is in focus.
Choose area in focus		If area of effect is in wide orientation, press ▲ or ▼ to position frame showing area of copy that will be in focus.
		If area of effect is in tall orientation, press ◀ or ▶ to position frame showing area of copy that will be in focus.
Choose size		If area of effect is in wide orientation, press ◀ or ▶ to choose height.
		If area of effect is in tall orientation, press ▲ or ▼ to choose width.
Preview copy		Preview copy.
Cancel		Exit to full-frame playback without creating copy.
Create copy		Create copy.

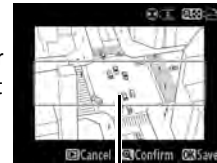

Area in focus



Selective Color

MENU button →  retouch menu



Create a copy in which only selected hues appear in color.

1 Select Selective color.

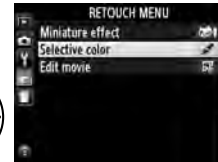
Highlight **Selective color** in the retouch menu and press  to display a picture selection dialog.







2 Select a photograph.

Highlight a photograph (to view the highlighted photograph full frame, press and hold the  button). Press  to select the highlighted photograph and proceed to the next step.



3 Select a color.

Use the multi selector to position the cursor over an object and press  () to select the color of the object as one that will remain in the final copy (the camera may have difficulty detecting unsaturated colors; choose a saturated color). To zoom in on the picture for precise color selection, press . Press  (?) to zoom out.

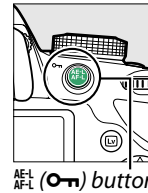

Selected color



4 Highlight the color range.

Rotate the command dial to highlight the color range for the selected color.

Color range





5 Choose the color range.

Press ▲ or ▼ to increase or decrease the range of similar hues that will be included in the final photograph or movie. Choose from values between 1 and 7; note that higher values may include hues from other colors. The effect can be previewed in the edit display.



6 Select additional colors.

To select additional colors, rotate the command dial to highlight another of the three color boxes at the top of the display and repeat Steps 3–5 to select another color. Repeat for a third color if desired. To deselect the highlighted color, press  (To remove all colors, press and hold . A confirmation dialog will be displayed; select **Yes**).



7 Save the edited copy.

Press  to copy the photograph.



Side-by-side Comparison

Compare retouched copies to the original photographs. This option is only available if the **OK** button is pressed to display the retouch menu when a copy or original is played back full frame.

1 Select a picture.

Select a retouched copy (shown by a  icon) or a photograph that has been retouched in full-frame playback and press **OK**.



2 Select Side-by-side comparison.

Highlight **Side-by-side comparison** in the retouch menu and press **OK**.



3 Compare the copy with the original.

The source image is displayed on the left, the retouched copy on the right, with the options used to create the copy listed at the top of the display. Press **◀** or **▶** to switch between the source image and the retouched copy. To view the highlighted picture full frame, press and hold the **Q** button. If the copy was created from two images using **Image overlay**, press **▲** or **▼** to view the other source image. If multiple copies exist for the current source image, press **▲** or **▼** to view the other copies. To exit to playback mode, press the **▶** button, or press **OK** to return to playback with the highlighted image displayed.

Options used to create copy

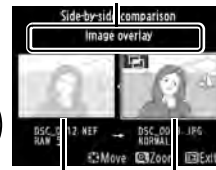

Source image Retouched copy

Side-by-side comparison

The source image will not be displayed if the copy was created from a photograph that has since been deleted or that was protected when the copy was made ( 105).



Recent Settings

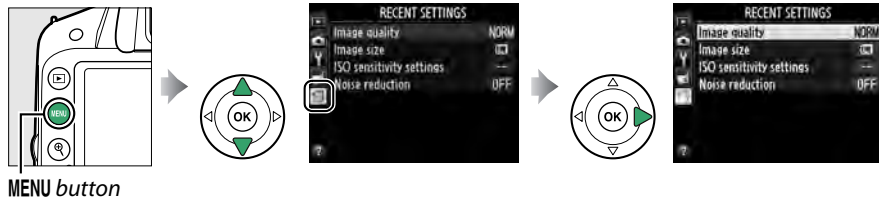

To display the recent settings menu, press **MENU** and select the  (recent settings) tab.

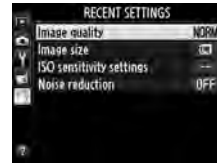

The recent settings menu lists the twenty most recently used settings. Press **▲** or **▼** to highlight an option and press **▶** to select.



Removing Items from the Recent Settings Menu

To remove an item from the recent settings menu, highlight it and press the  button. A confirmation dialog will be displayed; press  again to delete the selected item.





Technical Notes

Read this chapter for information on compatible accessories, cleaning and storing the camera, and what to do if an error message is displayed or you encounter problems using the camera.

Compatible Lenses

Compatible CPU Lenses

This camera supports autofocus with AF-S and AF-I CPU lenses only. AF-S lenses have names beginning with **AF-S**, AF-I lenses names beginning with **AF-I**. Autofocus is not supported with other autofocus (AF) lenses. The following table lists the features available with compatible lenses in viewfinder photography:

Lens/accessory	Camera setting				Focus		Mode		Metering		
	AF	MF (with electronic rangefinder)	MF	M	Other modes	3D		Color			
						3D	Color	3D	Color		
AF-S, AF-I NIKKOR ¹	✓	✓	✓	✓	✓	✓	—	✓ ²	—	✓ ²	
Other type G or D AF NIKKOR ¹	—	✓	✓	✓	✓	✓	—	✓ ²	—	✓ ²	
PC-E NIKKOR series	—	✓ ³	✓	✓ ³	✓ ³	✓ ³	—	✓ ^{2,3}	—	✓ ^{2,3}	
PC Micro 85mm f/2.8D ⁴	—	✓ ³	✓	✓	—	✓	—	✓ ^{2,3}	—	✓ ^{2,3}	
AF-S/AF-I teleconverter ⁵	✓ ⁶	✓ ⁶	✓	✓	✓	✓	—	✓ ²	—	✓ ²	
Other AF NIKKOR (except lenses for F3AF)	—	✓ ⁷	✓	✓	✓	—	—	✓ ²	—	✓ ²	
AI-P NIKKOR	—	✓ ⁸	✓	✓	✓	—	—	✓ ²	—	✓ ²	

- 1 Use AF-S or AF-I lenses to get the most from your camera. Vibration Reduction (VR) supported with VR lenses.
- 2 Spot metering meters selected focus point (□ 60).
- 3 Can not be used with shifting or tilting.
- 4 The camera's exposure metering and flash control systems may not function as expected when the lens is shifted and/or tilted or an aperture other than the maximum aperture is used.
- 5 AF-S or AF-I lens required.
- 6 With maximum effective aperture of f/5.6 or faster.
- 7 When AF 80–200mm f/2.8, AF 35–70mm f/2.8, AF 28–85mm f/3.5–4.5 (New), or AF 28–85mm f/3.5–4.5 lenses are zoomed all the way in at the minimum focus distance, the in-focus indicator may be displayed when the image on the matte screen in the viewfinder is not in focus. Focus manually until image in viewfinder is in focus.
- 8 With maximum aperture of f/5.6 or faster.

✓ IX NIKKOR Lenses

IX NIKKOR lenses can not be used.

✍ Lens f-number

The f-number given in lens names is the maximum aperture of the lens.



 **Identifying CPU and Type G and D Lenses**

CPU lenses can be identified by the presence of CPU contacts, type G and D lenses by a letter on the lens barrel. Type G lenses are not equipped with a lens aperture ring.

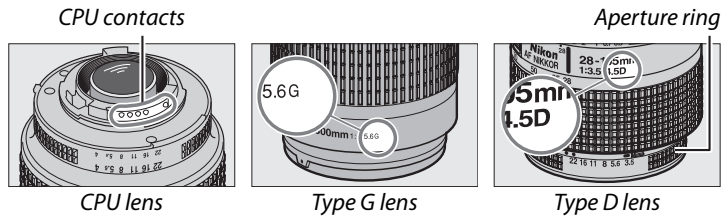

Compatible Non-CPU Lenses

Non-CPU lenses may only be used when the camera is in mode **M**. Selecting another mode disables the shutter release. Aperture must be adjusted manually via the lens aperture ring and the camera metering system, i-TTL flash control, and other features requiring a CPU lens can not be used. Some non-CPU lenses can not be used; see “Incompatible Accessories and Non-CPU Lenses,” below.

Lens/accessory	Camera setting		Focus			Mode	Metering
	AF	MF (with electronic rangefinder)	MF	M	Other modes	☺, ☺, ☺	
AI-, AI-modified NIKKOR or Nikon Series E lenses	—	✓ ¹	✓	✓ ²	—	—	
Medical NIKKOR 120mm f/4	—	✓	✓	✓ ^{2,3}	—	—	
Reflex NIKKOR	—	—	✓	✓ ²	—	—	
PC NIKKOR	—	✓ ⁴	✓	✓ ²	—	—	
AI-type Teleconverter	—	✓ ⁵	✓	✓ ²	—	—	
PB-6 Bellows Focusing Attachment ⁶	—	✓ ¹	✓	✓ ²	—	—	
Auto extension rings (PK-series 11A, 12, or 13; PN-11)	—	✓ ¹	✓	✓ ²	—	—	

1 With maximum aperture of f/5.6 or faster.

2 Exposure indicator can not be used.

3 Can be used at shutter speeds slower than flash sync speed by one step or more.

4 Can not be used with shifting or tilting.

5 With maximum effective aperture of f/5.6 or faster.

6 Attach in vertical orientation (can be used in horizontal orientation once attached).

✓ Incompatible Accessories and Non-CPU Lenses

The following accessories and non-CPU lenses can NOT be used with the D3200:

- TC-16AS AF teleconverter
- Non-AI lenses
- Lenses that require the AU-1 focusing unit (400mm f/4.5, 600mm f/5.6, 800mm f/8, 1200mm f/11)
- Fisheye (6mm f/5.6, 7.5mm f/5.6, 8mm f/8, OP 10mm f/5.6)
- 2.1cm f/4
- Extension Ring K2
- 180–600mm f/8 ED (serial numbers 174041–174180)
- 360–1200mm f/11 ED (serial numbers 174031–174127)
- 200–600mm f/9.5 (serial numbers 280001–300490)
- AF lenses for the F3AF (AF 80mm f/2.8, AF 200mm f/3.5 ED, AF Teleconverter TC-16)
- PC 28mm f/4 (serial number 180900 or earlier)
- PC 35mm f/2.8 (serial numbers 851001–906200)
- PC 35mm f/3.5 (old type)
- Reflex 1000mm f/6.3 (old type)
- Reflex 1000mm f/11 (serial numbers 142361–143000)
- Reflex 2000mm f/11 (serial numbers 200111–200310)



✓ The Built-in Flash

The built-in flash can be used with lenses with focal lengths of 18–300 mm, although in some cases the flash may be unable to entirely light the subject at some ranges or focal lengths due to shadows cast by the lens, while lenses that block the subject’s view of the red-eye reduction lamp may interfere with red-eye reduction. Remove lens hoods to prevent shadows. The flash has a minimum range of 0.6 m and can not be used in the macro range of macro zoom lenses. The flash may be unable to light the entire subject with the following lenses at ranges less than those given below:

Lens	Zoom position	Minimum distance without vignetting
AF-S DX NIKKOR 10–24mm f/3.5–4.5G ED	24 mm	2.5 m/ 8 ft 2 in.
AF-S DX Zoom-Nikkor 12–24mm f/4G IF-ED	24 mm	1.0 m/ 3 ft 3 in.
AF-S NIKKOR 16–35mm f/4G ED VR	35 mm	1.0 m/ 3 ft 3 in.
AF-S DX NIKKOR 16–85mm f/3.5–5.6G ED VR	24–85 mm	No vignetting
AF-S Zoom-Nikkor 17–35mm f/2.8D IF-ED	28 mm	1.0 m/ 3 ft 3 in.
	35 mm	No vignetting
AF-S DX Zoom-Nikkor 17–55mm f/2.8G IF-ED	28 mm	1.5 m/ 4 ft 11 in.
	35 mm	1.0 m/ 3 ft 3 in.
	45–55 mm	No vignetting
AF Zoom-Nikkor 18–35mm f/3.5–4.5D IF-ED	24 mm	1.0 m/ 3 ft 3 in.
	28–35 mm	No vignetting
AF-S DX Zoom-Nikkor 18–70mm f/3.5–4.5G IF-ED	18 mm	1.0 m/ 3 ft 3 in.
	24–70 mm	No vignetting
AF-S DX NIKKOR 18–105mm f/3.5–5.6G ED VR	18 mm	3.0 m/ 9 ft 10 in.
	24 mm	1.0 m/ 3 ft 3 in.
AF-S DX Zoom-Nikkor 18–135mm f/3.5–5.6G IF-ED	18 mm	2.0 m/ 6 ft 7 in.
	24–135 mm	No vignetting
AF-S DX VR Zoom-Nikkor 18–200mm f/3.5–5.6G IF-ED, AF-S DX NIKKOR 18–200mm f/3.5–5.6G ED VR II	24 mm	1.0 m/ 3 ft 3 in.
	35–200 mm	No vignetting
AF Zoom-Nikkor 20–35mm f/2.8D IF	24 mm	2.5 m/ 8 ft 2 in.
	28 mm	1.0 m/ 3 ft 3 in.
	35 mm	No vignetting
AF-S NIKKOR 24mm f/1.4G ED	24 mm	1.0 m/ 3 ft 3 in.
AF-S NIKKOR 24–70mm f/2.8G ED	35 mm	1.5 m/ 4 ft 11 in.
	50–70 mm	No vignetting
AF-S VR Zoom-Nikkor 24–120mm f/3.5–5.6G IF-ED	24 mm	1.0 m/ 3 ft 3 in.
	28–120 mm	No vignetting
AF-S NIKKOR 24–120mm f/4G ED VR	24 mm	1.5 m/ 4 ft 11 in.
AF-S Zoom-Nikkor 28–70mm f/2.8D IF-ED	35 mm	1.5 m/ 4 ft 11 in.
	50–70 mm	No vignetting
AF-S NIKKOR 28–300mm f/3.5–5.6G ED VR	28 mm	1.5 m/ 4 ft 11 in.
	35 mm	1.0 m/ 3 ft 3 in.



Lens	Zoom position	Minimum distance without vignetting
AF-S VR Zoom-Nikkor 200–400mm f/4G IF-ED	250 mm	2.5 m/8 ft 2 in.
	350 mm	2.0 m/6 ft 7 in.
AF-S NIKKOR 200–400mm f/4G ED VR II	200 mm	5.0 m/16 ft 5 in.
	250 mm	3.0 m/9 ft 10 in.
	300 mm	2.5 m/8 ft 2 in.
	350–400 mm	No vignetting
PC-E NIKKOR 24mm f/3.5D ED*	24 mm	3.0 m/9 ft 10 in.

* When not shifted or tilted.

When used with the AF-S NIKKOR 14–24mm f/2.8G ED, the flash will be unable to light the entire subject at all ranges.

✓ AF-Assist Illumination

AF-assist illumination is not available with the following lenses:

- AF-S NIKKOR 14–24mm f/2.8G ED
- AF-S NIKKOR 28–300mm f/3.5–5.6G ED VR
- AF-S DX NIKKOR 55–300mm f/4.5–5.6G ED VR
- AF-S VR Zoom-Nikkor 70–200mm f/2.8G IF-ED
- AF-S NIKKOR 70–200mm f/2.8G ED VR II
- AF-S Zoom-Nikkor 80–200mm f/2.8D IF-ED
- AF-S VR Nikkor 200mm f/2G IF-ED
- AF-S NIKKOR 200mm f/2G ED VR II
- AF-S VR Zoom-Nikkor 200–400mm f/4G IF-ED
- AF-S NIKKOR 200–400mm f/4G ED VR II

At ranges under 1 m (3 ft 3 in.), the following lenses may block the AF-assist illuminator and interfere with autofocus when lighting is poor:

- AF-S NIKKOR 16–35mm f/4G ED VR
- AF-S Zoom-Nikkor 17–35mm f/2.8D IF-ED
- AF-S DX Zoom-Nikkor 17–55mm f/2.8G IF-ED
- AF-S DX NIKKOR 18–105mm f/3.5–5.6G ED VR
- AF-S DX VR Zoom-Nikkor 18–200mm f/3.5–5.6G IF-ED
- AF-S DX NIKKOR 18–200mm f/3.5–5.6G ED VR II
- AF-S NIKKOR 24–70mm f/2.8G ED
- AF-S VR Zoom-Nikkor 24–120mm f/3.5–5.6G IF-ED
- AF-S NIKKOR 24–120mm f/4G ED VR
- AF-S Zoom-Nikkor 28–70mm f/2.8D IF-ED
- AF-S NIKKOR 35mm f/1.4G
- AF-S NIKKOR 85mm f/1.4G
- AF-S VR Micro-Nikkor 105mm f/2.8G IF-ED

✍ Calculating Angle of View

The size of the area exposed by a 35mm camera is 36×24 mm. The size of the area exposed by the D3200, in contrast, is 23.2×15.4 mm, meaning that the angle of view of a 35mm camera is approximately 1.5 times that of the D3200. The approximate focal length of lenses for the D3200 in 35mm format can be calculated by multiplying the focal length of the lens by about 1.5.

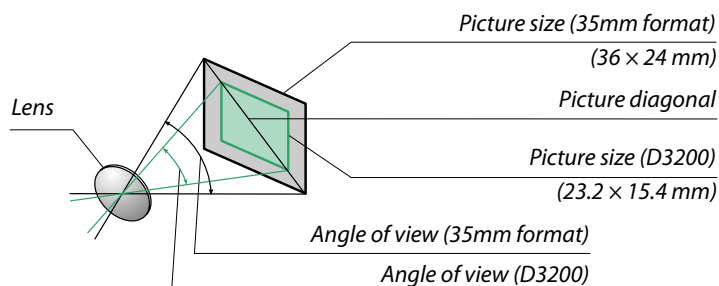

Optional Flash Units (Speedlights)

The camera supports the Nikon Creative Lighting System (CLS) and can be used with CLS-compatible flash units. Optional flash units can be attached directly to the camera accessory shoe as described below. The accessory shoe is equipped with a safety lock for flash units with a locking pin.

1 Remove the accessory shoe cover.

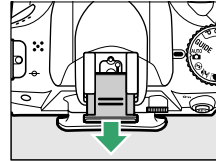

2 Mount the flash unit on the accessory shoe.

See the manual provided with the flash unit for details. The built-in flash will not fire when an optional flash unit is attached.

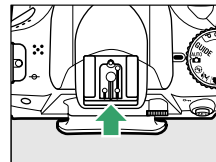

The AS-15 Sync Terminal Adapter

When the AS-15 sync terminal adapter (available separately) is mounted on the camera accessory shoe, flash accessories can be connected via a sync cable.

Use Only Nikon Flash Accessories

Use only Nikon flash units. Negative voltages or voltages over 250 V applied to the accessory shoe could not only prevent normal operation, but damage the sync circuitry of the camera or flash. Before using a Nikon flash unit not listed in this section, contact a Nikon-authorized service representative for more information.

The Nikon Creative Lighting System (CLS)

Nikon's advanced Creative Lighting System (CLS) offers improved communication between the camera and compatible flash units for improved flash photography.

■ CLS-Compatible Flash Units

The camera can be used with the following CLS-compatible flash units:

Feature		Flash unit						
		SB-910 ¹	SB-900 ¹	SB-800	SB-700 ¹	SB-600	SB-400 ²	SB-R200 ³
Guide No. ⁴	ISO 100	34/111	34/111	38/125	28/92	30/98	21/69	10/33
	ISO 200	48/157	48/157	53/174	39/128	42/138	30/98	14/46

1 If a color filter is attached to the SB-910, SB-900, or SB-700 when **AUTO** or  (flash) is selected for white balance, the camera will automatically detect the filter and adjust white balance appropriately.

2 Wireless flash control is not available with the SB-400.

3 Controlled remotely using optional SB-910, SB-900, SB-800, or SB-700 flash unit or SU-800 wireless Speedlight commander.

4 m/ft, 20 °C (68 °F), SB-910, SB-900, SB-800, SB-700, and SB-600 at 35 mm zoom head position; SB-910, SB-900, and SB-700 with standard illumination.

- **The SU-800 wireless speedlight commander:** When mounted on a CLS-compatible camera, the SU-800 can be used as a commander for remote SB-910, SB-900, SB-800, SB-700, SB-600, or SB-R200 flash units in up to three groups. The SU-800 itself is not equipped with a flash.

Guide Number

To calculate the range of the flash at full power, divide the Guide Number by the aperture. For example, at ISO 100 the SB-800 has a Guide Number of 38 m or 125 ft (35 mm zoom head position); its range at an aperture of f/5.6 is $38 \div 5.6$ or about 6.8 meters (or in feet, $125 \div 5.6 =$ approximately 23 ft 7 in.). For each twofold increase in ISO sensitivity, multiply the Guide Number by the square root of two (approximately 1.4).



The following features are available with CLS-compatible flash units:

Flash unit		Advanced Wireless Lighting									
							Master/commander			Remote	
		SB-910 SB-900 SB-800	SB-700	SB-600	SB-400	SB-910 SB-900 SB-800	SB-700	SU-800 ¹	SB-910 SB-900 SB-800	SB-700 SB-600	SB-R200
i-TTL	i-TTL balanced fill-flash for digital SLR ²	✓ ³	✓ ⁴	✓ ³	✓ ⁴	✓	✓	✓	✓	✓	✓
AA	Auto aperture ²	✓ ⁵	—	—	—	✓ ⁶	—	✓ ⁶	✓ ⁶	—	—
A	Non-TTL auto	✓ ⁵	—	—	—	✓ ⁶	—	—	✓ ⁶	—	—
GN	Distance-priority manual	✓	✓	—	—	—	—	—	—	—	—
M	Manual	✓	✓	✓	✓ ⁷	✓	✓	✓	✓	✓	✓
RPT	Repeating flash	✓	—	—	—	✓	—	✓	✓	✓	—
AF-assist for multi-area AF ²		✓	✓	✓	—	✓	✓	✓	—	—	—
Flash Color Information Communication		✓	✓	✓	✓	✓	✓	—	—	—	—
REAR	Rear-curtain sync	✓	✓	✓	✓	✓	✓	✓	✓	✓	✓
👁	Red-eye reduction	✓	✓	✓	✓	✓	✓	—	—	—	—
Power zoom		✓	✓	✓	—	✓	✓	—	—	—	—

¹ Only available when SU-800 is used to control other flash units. The SU-800 itself is not equipped with a flash.

² CPU lens required.

³ Standard i-TTL flash for digital SLR is used with spot metering or when selected with flash unit.

⁴ Standard i-TTL flash for digital SLR is used with spot metering.

⁵ Selected with flash unit.

⁶ Auto aperture (AA) is used regardless of mode selected with flash unit.

⁷ Can be selected with camera.

■ Other Flash Units

The following flash units can be used in non-TTL auto and manual modes.

Flash unit		SB-80DX, SB-28DX, SB-28, SB-26, SB-25, SB-24	SB-50DX ¹	SB-30, SB-27 ² , SB-22S, SB-22, SB-20, SB-16B, SB-15	SB-23, SB-29 ³ , SB-21B ³ , SB-29S ³
A	Non-TTL auto	✓	—	✓	—
M	Manual	✓	✓	✓	✓
🔁	Repeating flash	✓	—	—	—
REAR	Rear-curtain sync ⁴	✓	✓	✓	✓

¹ Select mode P, S, A, or M, lower built-in flash, and use optional flash unit only.

² Flash mode is automatically set to TTL and shutter-release is disabled. Set flash unit to A (non-TTL auto flash).



³ Autofocus is available with AF-S VR Micro-Nikkor 105mm f/2.8G IF-ED and AF-S Micro NIKKOR 60mm f/2.8G ED lenses only.

⁴ Available when camera is used to select flash mode.



✓ Notes on Optional Flash Units

Refer to the Speedlight manual for detailed instructions. If the flash unit supports CLS, refer to the section on CLS-compatible digital SLR cameras. The D3200 is not included in the “digital SLR” category in the SB-80DX, SB-28DX, and SB-50DX manuals.

If an optional flash unit is attached in shooting modes other than , the flash will fire with every shot, even in modes in which the built-in flash can not be used ( and ).

i-TTL flash control can be used at ISO sensitivities between 100 and 6400. At values over 6400, the desired results may not be achieved at some ranges or aperture settings. If the flash-ready indicator flashes for about three seconds after a photograph is taken, the flash has fired at full power and the photograph may be underexposed.

When an SC-series 17, 28, or 29 sync cable is used for off-camera flash photography, correct exposure may not be achieved in i-TTL mode. We recommend that you choose spot metering to select standard i-TTL flash control. Take a test shot and view the results in the monitor.

In i-TTL, use the flash panel or bounce adapter provided with the flash unit. Do not use other panels such as diffusion panels, as this may produce incorrect exposure.

If the controls on the optional SB-910, SB-900, SB-800, SB-700 or SB-600 flash unit or SU-800 wireless Speedlight commander are used to set flash compensation,  will appear in the information display.

The SB-910, SB-900, SB-800, SB-700, SB-600, and SB-400 provide red-eye reduction, while the SB-910, SB-900, SB-800, SB-700, SB-600, and SU-800 provide AF-assist illumination with the following restrictions:

- **SB-910 and SB-900:** AF-assist illumination is available with 17–135 mm AF lenses, however, autofocus is available only with the focus points shown at right.
- **SB-800, SB-600, and SU-800:** AF-assist illumination is available with 24–105 mm AF lenses, however, autofocus is available only with the focus points shown at right.
- **SB-700:** AF-assist illumination is available with 24–135 mm AF lenses, however, autofocus is available only with the focus points shown at right.

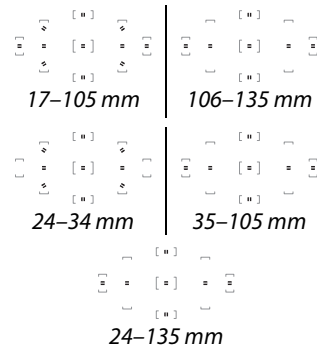

Other Accessories

At the time of writing, the following accessories were available for the D3200.

Power sources	<ul style="list-style-type: none"> • Rechargeable Li-ion Battery EN-EL14 (□ 12–13): Additional EN-EL14 batteries are available from local retailers and Nikon-authorized service representatives. EN-EL14a batteries can also be used. • Battery Charger MH-24 (□ 12): Recharge EN-EL14a and EN-EL14 batteries. • Power Connector EP-5A, AC Adapter EH-5b: These accessories can be used to power the camera for extended periods (EH-5a and EH-5 AC adapters can also be used). A power connector EP-5A is required to connect the camera to the EH-5b, EH-5a, or EH-5; see page 178 for details.
Filters	<ul style="list-style-type: none"> • Filters intended for special-effects photography may interfere with autofocus or the electronic rangefinder. • The D3200 can not be used with linear polarizing filters. Use C-PL or C-PL II circular polarizing filters instead. • NC filters are recommended for protecting the lens. • To prevent ghosting, use of a filter is not recommended when the subject is framed against a bright light, or when a bright light source is in the frame. • Center-weighted metering is recommended with filters with exposure factors (filter factors) over 1 × (Y44, Y48, Y52, O56, R60, X0, X1, C-PL, ND2S, ND4, ND4S, ND8, ND8S, ND400, A2, A12, B2, B8, B12). See the filter manual for details.
Viewfinder eyepiece accessories	<ul style="list-style-type: none"> • DK-20C Eyepiece Correction Lenses: Lenses are available with diopters of -5, -4, -3, -2, 0, $+0.5$, $+1$, $+2$, and $+3$ m^{-1} when the camera diopter adjustment control is in the neutral position (-1 m^{-1}). Use eyepiece correction lenses only if the desired focus can not be achieved with the built in diopter adjustment control (-1.7 to $+0.5$ m^{-1}). Test eyepiece correction lenses before purchase to ensure that the desired focus can be achieved. The rubber eyecup can not be used with eyepiece correction lenses. • Magnifier DG-2: The DG-2 magnifies the scene displayed in the center of the viewfinder for greater precision during focusing. Eyepiece adapter required (available separately). • Eyepiece Adapter DK-22: The DK-22 is used when attaching the DG-2 magnifier. • Right-Angle Viewing Attachment DR-6: The DR-6 attaches at a right angle to the viewfinder eyepiece, allowing the image in the viewfinder to be viewed at right angles to the lens (for example, from directly above when the camera is horizontal).
Software	<p>Capture NX 2: A complete photo editing package offering such features as white balance adjustment and color control points.</p> <p>Note: Use the latest versions of Nikon software. Most Nikon software offers an auto update feature when the computer is connected to the Internet. See the websites listed on page xiv for the latest information on supported operating systems.</p>

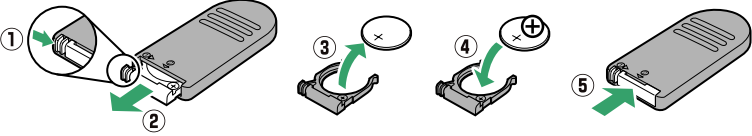
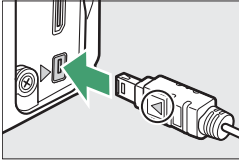

Body cap	Body Cap BF-1B/Body Cap BF-1A: The body cap keeps the mirror, viewfinder screen, and low-pass filter free of dust when a lens is not in place.
Remote controls	<p>ML-L3 wireless remote control (□ 33): The ML-L3 uses a 3 V CR2025 battery.</p>  <p>Pressing the battery-chamber latch to the right (①), insert a fingernail into the gap and open the battery chamber (②). Ensure that the battery is inserted in the correct orientation (④).</p>
Microphones	Stereo Microphone ME-1 (□ 91)
Accessory terminal accessories	<p>The D3200 is equipped with an accessory terminal for MC-DC2 remote cords (□ 58) and GP-1 GPS units (□ 147), which connect with the ◀ mark on the connector aligned with the ▶ next to the accessory terminal (close the connector cover when the terminal is not in use).</p> 
USB and A/V connector accessories	<ul style="list-style-type: none"> • UC-E17 and UC-E6 USB cables (□ 112) • Wireless Mobile Adapter WU-1a: Supports two-way communication between the camera and smart devices running the Wireless Mobile Adapter Utility.

Approved Memory Cards

The following SD memory cards have been tested and approved for use in the D3200. Cards with class 6 or faster write speeds are recommended for movie recording. Recording may end unexpectedly when cards with slower write speeds are used.

	SD memory cards	SDHC memory cards ²	SDXC memory cards ³
SanDisk	2 GB ¹	4 GB, 8 GB, 16 GB, 32 GB	64 GB
Toshiba		4 GB, 6 GB, 8 GB, 12 GB, 16 GB, 24 GB, 32 GB	48 GB, 64 GB
Panasonic			
Lexar Media		4 GB, 8 GB, 16 GB, 32 GB	—
Platinum II		4 GB, 8 GB, 16 GB, 32 GB, 64 GB, 128 GB	
Professional			
Full-HD Video	—	4 GB, 8 GB, 16 GB	

1 Check that any card readers or other devices with which the card will be used support 2 GB cards.

2 Check that any card readers or other devices with which the card will be used are SDHC-compliant. The camera supports UHS-1.

3 Check that any card readers or other devices with which the card will be used are SDXC-compliant. The camera supports UHS-1.



Other cards have not been tested. For more details on the above cards, please contact the manufacturer.



Attaching a Power Connector and AC Adapter

Turn the camera off before attaching an optional power connector and AC adapter.

1 Ready the camera.

Open the battery-chamber (①) and power connector (②) covers.

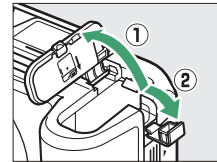

2 Insert the EP-5A power connector.

Be sure to insert the connector in the orientation shown, using the connector to keep the orange battery latch pressed to one side. The latch locks the connector in place when the connector is fully inserted.

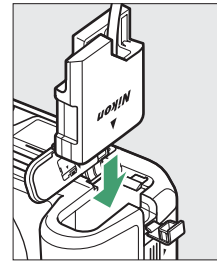

3 Close the battery-chamber cover.

Position the power connector cable so that it passes through the power connector slot and close the battery-chamber cover.

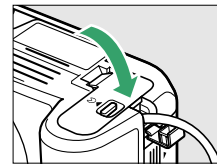

4 Connect the AC adapter.

Connect the AC adapter power cable to the AC socket (③) and the EP-5A power cable to the DC socket (④). A  icon is displayed in the monitor when the camera is powered by the AC adapter and power connector.

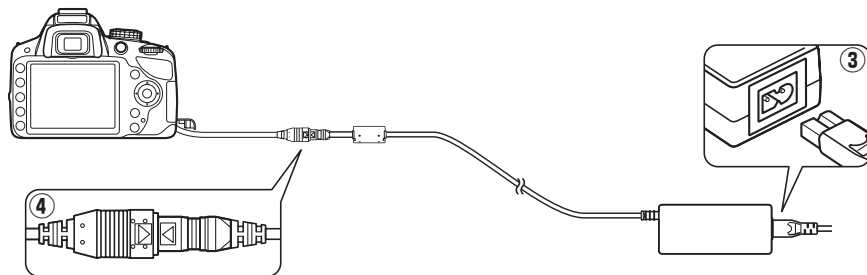

Caring for the Camera

Storage

When the camera will not be used for an extended period, remove the battery and store it in a cool, dry area with the terminal cover in place. To prevent mold or mildew, store the camera in a dry, well-ventilated area. Do not store your camera with naphtha or camphor moth balls or in locations that:

- are poorly ventilated or subject to humidities of over 60%
- are next to equipment that produces strong electromagnetic fields, such as televisions or radios
- are exposed to temperatures above 50 °C (122 °F) or below –10 °C (14 °F)

Cleaning

Camera body	Use a blower to remove dust and lint, then wipe gently with a soft, dry cloth. After using the camera at the beach or seaside, wipe off sand or salt with a cloth lightly dampened in distilled water and dry thoroughly. Important: <i>Dust or other foreign matter inside the camera may cause damage not covered under warranty.</i>
Lens, mirror, and viewfinder	These glass elements are easily damaged. Remove dust and lint with a blower. If using an aerosol blower, keep the can vertical to prevent the discharge of liquid. To remove fingerprints and other stains, apply a small amount of lens cleaner to a soft cloth and clean with care.
Monitor	Remove dust and lint with a blower. When removing fingerprints and other stains, wipe the surface lightly with a soft cloth or chamois leather. Do not apply pressure, as this could result in damage or malfunction.

Do not use alcohol, thinner, or other volatile chemicals.

Servicing the Camera and Accessories

The camera is a precision device and requires regular servicing. Nikon recommends that the camera be inspected by the original retailer or Nikon-authorized service representative once every one to two years, and that it be serviced once every three to five years (note that fees apply to these services). Frequent inspection and servicing are particularly recommended if the camera is used professionally. Any accessories regularly used with the camera, such as lenses or optional flash units, should be included when the camera is inspected or serviced.



The Low-Pass Filter

The image sensor that acts as the camera's picture element is fitted with a low-pass filter to prevent moiré. If you suspect that dirt or dust on the filter is appearing in photographs, you can clean the filter using the **Clean image sensor** option in the setup menu. The filter can be cleaned at any time using the **Clean now** option, or cleaning can be performed automatically when the camera is turned on or off.

■ ■ "Clean Now"

1 Place the camera base down.

Image sensor cleaning is most effective when the camera is placed base down as shown at right.

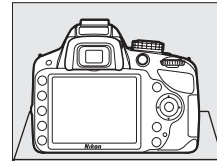

2 Select Clean image sensor in the setup menu.

Press the MENU button to display the menus. Highlight **Clean image sensor** in the setup menu (133) and press ►.

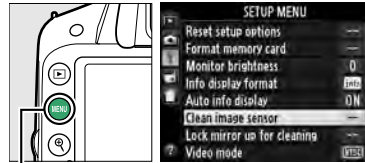

MENU button

3 Select Clean now.

Highlight **Clean now** and press OK.



The camera will check the image sensor and then begin cleaning. **b5y** flashes in the viewfinder and other operations can not be performed. Do not remove or disconnect the power source until cleaning is complete and the message shown at right is no longer displayed.

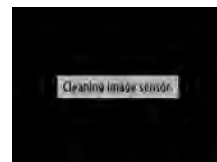

■ ■ “Clean at Startup/Shutdown”

Choose from the following options:

Option	Description
☉ON Clean at startup	The image sensor is automatically cleaned each time the camera is turned on.
☉OFF Clean at shutdown	The image sensor is automatically cleaned during shutdown each time the camera is turned off.
☉ON/OFF Clean at startup & shutdown	The image sensor is cleaned automatically at startup and at shutdown.
Cleaning off	Automatic image sensor cleaning off.

1 Select Clean image sensor in the setup menu.

Press the MENU button to display the menus. Highlight **Clean image sensor** in the setup menu (☰ 133) and press ►.

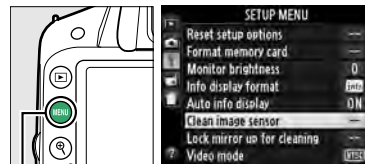

MENU button

2 Select Clean at startup/shutdown.

Highlight **Clean at startup/shutdown** and press ►.



3 Select an option.

Highlight an option and press OK.



✓ Image Sensor Cleaning

Using camera controls during startup interrupts image sensor cleaning. Image sensor cleaning may not be performed at startup if the flash is charging.

Cleaning is performed by vibrating the low-pass filter. If dust can not be fully removed using the options in the **Clean image sensor** menu, clean the image sensor manually (☰ 182) or consult a Nikon-authorized service representative.

If image sensor cleaning is performed several times in succession, image sensor cleaning may be temporarily disabled to protect the camera's internal circuitry. Cleaning can be performed again after a short wait.



Manual Cleaning

If foreign matter can not be removed from the low-pass filter using the **Clean image sensor** option in the setup menu (☐ 180), the filter can be cleaned manually as described below. Note, however, that the filter is extremely delicate and easily damaged. Nikon recommends that the filter be cleaned only by Nikon-authorized service personnel.

1 Charge the battery or connect an AC adapter.

A reliable power source is required when inspecting or cleaning the low-pass filter. Turn the camera off and insert a fully-charged EN-EL14 battery or connect an optional EP-5A power connector and EH-5b AC adapter.

2 Remove the lens.

Turn the camera off and remove the lens.

3 Select Lock mirror up for cleaning.

Turn the camera on and press the **MENU** button to display the menus. Highlight **Lock mirror up for cleaning** in the setup menu and press **▶** (note that this option is not available at battery levels of  or below).

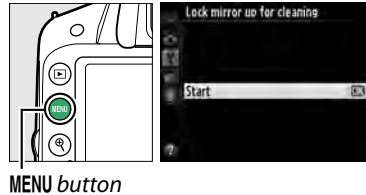

4 Press **OK**.

The message shown at right will be displayed in the monitor. To restore normal operation without inspecting the low-pass filter, turn the camera off.

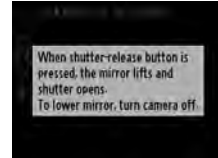

5 Raise the mirror.

Press the shutter-release button all the way down. The mirror will be raised and the shutter curtain will open, revealing the low-pass filter.



6 Examine the low-pass filter.

Holding the camera so that light falls on the low-pass filter, examine the filter for dust or lint. If no foreign objects are present, proceed to Step 8.

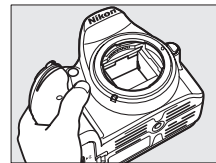

7 Clean the filter.

Remove any dust and lint from the filter with a blower. Do not use a blower-brush, as the bristles could damage the filter. Dirt that can not be removed with a blower can only be removed by Nikon-authorized service personnel. Under no circumstances should you touch or wipe the filter.

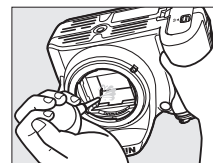

8 Turn the camera off.

The mirror will return to the down position and the shutter curtain will close. Replace the lens or body cap.

Use a Reliable Power Source

The shutter curtain is delicate and easily damaged. If the camera powers off while the mirror is raised, the curtain will close automatically. To prevent damage to the curtain, observe the following precautions:

- Do not turn the camera off or remove or disconnect the power source while the mirror is raised.
- If the battery runs low while the mirror is raised, a beep will sound and the self-timer lamp will flash to warn that the shutter curtain will close and the mirror will be lowered after about two minutes. End cleaning or inspection immediately.

Foreign Matter on the Low-Pass Filter

Nikon takes every possible precaution to prevent foreign matter from coming into contact with the low-pass filter during production and shipping. The D3200, however, is designed to be used with interchangeable lenses, and foreign matter may enter the camera when lenses are removed or exchanged. Once inside the camera, this foreign matter may adhere to the low-pass filter, where it may appear in photographs taken under certain conditions. To protect the camera when no lens is in place, be sure to replace the body cap provided with the camera, being careful to first remove all dust and other foreign matter that may be adhering to the body cap. Avoid exchanging lenses in dusty environments.

Should foreign matter find its way onto the low-pass filter, clean the filter as described above, or have the filter cleaned by authorized Nikon service personnel. Photographs affected by the presence of foreign matter on the filter can be retouched using Capture NX 2 (available separately; □ 176) or the clean image options available in some third-party imaging applications.



Caring for the Camera and Battery: Cautions

Caring for the Camera

Do not drop: The product may malfunction if subjected to strong shocks or vibration.

Keep dry: This product is not waterproof, and may malfunction if immersed in water or exposed to high levels of humidity. Rusting of the internal mechanism can cause irreparable damage.

Avoid sudden changes in temperature: Sudden changes in temperature, such as those that occur when entering or leaving a heated building on a cold day, can cause condensation inside the device. To prevent condensation, place the device in a carrying case or plastic bag before exposing it to sudden changes in temperature.

Keep away from strong magnetic fields: Do not use or store this device in the vicinity of equipment that generates strong electromagnetic radiation or magnetic fields. Strong static charges or the magnetic fields produced by equipment such as radio transmitters could interfere with the monitor, damage data stored on the memory card, or affect the product's internal circuitry.

Do not leave the lens pointed at the sun: Do not leave the lens pointed at the sun or other strong light source for an extended period. Intense light may cause the image sensor to deteriorate or produce a white blur effect in photographs.

Turn the product off before removing or disconnecting the power source: Do not unplug the product or remove the battery while the product is on or while images are being recorded or deleted. Forcibly cutting power in these circumstances could result in loss of data or in damage to product memory or internal circuitry. To prevent an accidental interruption of power, avoid carrying the product from one location to another while the AC adapter is connected.

Cleaning: When cleaning the camera body, use a blower to gently remove dust and lint, then wipe gently with a soft, dry cloth. After using the camera at the beach or seaside, wipe off any sand or salt using a cloth lightly dampened in pure water and then dry the camera thoroughly.

The lens and mirror are easily damaged. Dust and lint should be gently removed with a blower. When using an aerosol blower, keep the can vertical to prevent discharge of liquid. To remove fingerprints and other stains from the lens, apply a small amount of lens cleaner to a soft cloth and wipe the lens carefully.

See "The Low-Pass Filter" (📖 180, 182) for information on cleaning the low-pass filter.

Do not touch the shutter curtain: The shutter curtain is extremely thin and easily damaged. Under no circumstances should you exert pressure on the curtain, poke it with cleaning tools, or subject it to powerful air currents from a blower. These actions could scratch, deform, or tear the curtain.



Storage: To prevent mold or mildew, store the camera in a dry, well-ventilated area. If you are using an AC adapter, unplug the adapter to prevent fire. If the product will not be used for an extended period, remove the battery to prevent leakage and store the camera in a plastic bag containing a desiccant. Do not, however, store the camera case in a plastic bag, as this may cause the material to deteriorate. Note that desiccant gradually loses its capacity to absorb moisture and should be replaced at regular intervals.

To prevent mold or mildew, take the camera out of storage at least once a month. Turn the camera on and release the shutter a few times before putting it away.

Store the battery in a cool, dry place. Replace the terminal cover before putting the battery away.

Notes on the monitor: The monitor is constructed with extremely high precision; at least 99.99% of pixels are effective, with no more than 0.01% being missing or defective. Hence while these displays may contain pixels that are always lit (white, red, blue, or green) or always off (black), this is not a malfunction and has no effect on images recorded with the device.

Images in the monitor may be difficult to see in a bright light.

Do not apply pressure to the monitor, as this could cause damage or malfunction. Dust or lint on the monitor can be removed with a blower. Stains can be removed by wiping lightly with a soft cloth or chamois leather. Should the monitor break, care should be taken to avoid injury from broken glass and to prevent liquid crystal from the monitor touching the skin or entering the eyes and mouth.

Moiré: Moiré is an interference pattern created by the interaction of an image containing a regular, repeating grid, such as the pattern of weave in cloth or windows in a building, with the camera image sensor grid. If you notice moiré in your photographs, try changing the distance to the subject, zooming in and out, or changing the angle between the subject and the camera.

Caring for the Battery

Batteries may leak or explode if improperly handled. Observe the following precautions when handling batteries:

- Use only batteries approved for use in this equipment.
- Do not expose the battery to flame or excessive heat.
- Keep the battery terminals clean.
- Turn the product off before replacing the battery.
- Remove the battery from the camera or charger when not in use and replace the terminal cover. These devices draw minute amounts of charge even when off and could draw the battery down to the point that it will no longer function. If the battery will not be used for some time, insert it in the camera and run it flat before removing it and storing it in a location with an ambient temperature of 15 to 25 °C (59 to 77 °F; avoid hot or extremely cold locations). Repeat this process at least once every six months.
- Turning the camera on and off repeatedly when the battery is fully discharged will shorten battery life. Batteries that have been fully discharged must be charged before use.



- The internal temperature of the battery may rise while the battery is in use. Attempting to charge the battery while the internal temperature is elevated will impair battery performance, and the battery may not charge or charge only partially. Wait for the battery to cool before charging.
- Continuing to charge the battery after it is fully charged can impair battery performance.
- A marked drop in the time a fully charged battery retains its charge when used at room temperature indicates that it requires replacement. Purchase a new EN-EL14 battery.
- Charge the battery before use. When taking photographs on important occasions, ready a spare EN-EL14 battery and keep it fully charged. Depending on your location, it may be difficult to purchase replacement batteries on short notice. Note that on cold days, the capacity of batteries tends to decrease. Be sure the battery is fully charged before taking photographs outside in cold weather. Keep a spare battery in a warm place and exchange the two as necessary. Once warmed, a cold battery may recover some of its charge.
- Used batteries are a valuable resource; recycle in accord with local regulations.



Available Settings

The following table lists the settings that can be adjusted in each mode. Defaults can be restored with **Reset shooting menu** (□ 128).

Shooting menu	Set Picture Control	—	—	—	—	—	—	—	—	—	✓	✓	✓	✓	
	Image quality	✓	✓	✓	✓	✓	✓	✓	✓	✓	✓	✓	✓	✓	
	Image size	✓	✓	✓	✓	✓	✓	✓	✓	✓	✓	✓	✓	✓	
	White balance	—	—	—	—	—	—	—	—	—	✓	✓	✓	✓	
	ISO sensitivity settings	—	—	✓	✓	✓	✓	✓	✓	✓	✓	✓	✓	✓	
	Active D-Lighting	—	—	—	—	—	—	—	—	—	✓	✓	✓	✓	
	Auto distortion control	✓	✓	✓	✓	✓	✓	✓	✓	✓	✓	✓	✓	✓	
	Color space	✓	✓	✓	✓	✓	✓	✓	✓	✓	✓	✓	✓	✓	
	Noise reduction	✓	✓	✓	✓	✓	✓	✓	✓	✓	✓	✓	✓	✓	
	AF-area mode	Viewfinder	✓*	✓*	✓*	✓*	✓*	✓*	✓*	✓*	✓*	✓*	✓*	✓*	✓*
		Live view/movie	—	—	✓*	✓*	✓*	✓*	✓*	✓*	✓*	✓*	✓*	✓*	✓*
	Built-in AF-assist illuminator	✓	✓	✓	—	✓	—	✓	✓	✓	✓	✓	✓	✓	✓
	Metering	—	—	—	—	—	—	—	—	—	✓	✓	✓	✓	✓
	Movie settings	✓	✓	✓	✓	✓	✓	✓	✓	✓	✓	✓	✓	✓	✓
	Flash cntrl for built-in flash/Optional flash	—	—	—	—	—	—	—	—	—	✓	✓	✓	✓	✓
	Other settings	Release mode	✓*	✓*	✓*	✓*	✓*	✓*	✓*	✓*	✓*	✓*	✓*	✓*	✓*
		AE-L/AF-L button hold	—	—	✓*	✓*	✓*	✓*	✓*	✓*	✓*	✓*	✓*	✓*	✓*
Focus mode		✓	✓	✓	✓	✓	✓	✓	✓	✓	✓	✓	✓	✓	
Flexible program		—	—	—	—	—	—	—	—	—	✓*	—	—	—	
Exposure compensation		—	—	—	—	—	—	—	—	—	✓	✓	✓	✓	✓
Flash mode		✓*	—	✓*	—	✓*	—	✓*	✓*	✓*	✓*	✓*	✓*	✓*	✓*
Flash compensation	—	—	—	—	—	—	—	—	—	✓	✓	✓	✓	✓	

* Reset when mode dial is rotated to new setting.



Memory Card Capacity

The following table shows the approximate number of pictures that can be stored on a 8 GB SanDisk Extreme Pro SDHC UHS-I card at different image quality and size settings. Note that buffer capacity drops at ISO sensitivities of 1600 or higher.

Image quality	Image size	File size ¹	No. of images ¹	Buffer capacity ²
NEF (RAW)+ JPEG fine ³	Large	31.9 MB	171	10
NEF (RAW)	—	20.4 MB	259	18
JPEG fine	Large	11.9 MB	509	80
	Medium	7.4 MB	853	100
	Small	3.8 MB	1600	100
JPEG normal	Large	6.2 MB	1000	100
	Medium	3.7 MB	1600	100
	Small	1.9 MB	3200	100
JPEG basic	Large	3.0 MB	1900	100
	Medium	1.9 MB	3200	100
	Small	1.0 MB	6300	100

¹ All figures are approximate. Results will vary with card type, camera settings, and scene recorded.

² Maximum number of exposures that can be stored in memory buffer at ISO 100. Drops when noise reduction (☐ 131) or auto distortion control (☐ 130) is on.

³ Image size applies to JPEG images only. Size of NEF (RAW) images can not be changed. File size is the total for NEF (RAW) and JPEG images.

File Names

Photographs are stored as image files with names of the form “DSC_####.xxx,” where #### is a four-digit number between 0001 and 9999 assigned automatically in ascending order by the camera, and xxx is one of the following three letter extensions: “NEF” for NEF images, “JPG” for JPEG images, or “MOV” for movies. The NEF and JPEG files recorded at a setting of **NEF (RAW) + JPEG fine** have the same file names but different extensions. Copies created with image overlay (☐ 155) and movie edit options (☐ 93) have file names beginning with “DSC_”; copies created with the other options in the retouch menu have file names beginning with “CSC” (e.g., “CSC_0001.JPG”). Images recorded with the **Color space** option in the shooting menu set to **Adobe RGB** (☐ 130) have names that begin with an underscore (e.g., “_DSC0001.JPG”).

Troubleshooting

If the camera fails to function as expected, check the list of common problems below before consulting your retailer or Nikon representative.

Display

Viewfinder is out of focus: Adjust viewfinder focus or use optional eyepiece correction lenses (☐ 20, 176).

Displays turn off without warning: Choose longer delays for **Auto off timers** (☐ 140).

Information display does not appear in monitor: Shutter-release button is pressed halfway. If information display does not appear when you remove your finger from shutter-release button, confirm that **On** is selected for **Auto info display** (☐ 136) and that battery is charged.

Viewfinder display is unresponsive and dim: The response times and brightness of this display vary with temperature.

If the Camera Stops Responding

In extremely rare instances, the displays may not respond as expected and the camera may stop functioning. In most cases, this phenomenon is caused by a strong external static charge. Turn the camera off, remove and replace the battery, taking care to avoid burns, and turn the camera on again, or, if you are using an AC adapter (available separately), disconnect and reconnect the adapter and turn the camera on again. If the problem persists after removing the battery from the camera, contact your retailer or Nikon-authorized service representative.

Shooting (All Modes)

Camera takes time to turn on: Delete files or folders.

Shutter-release disabled:

- Memory card is locked, full, or not inserted (☐ 18, 21).
- **Release locked** is selected for **Slot empty release lock**; (☐ 144) and no memory card is inserted (☐ 18).
- Built-in flash is charging (☐ 24).
- Camera is not in focus (☐ 23).
- CPU lens with aperture ring attached but aperture not locked at highest f-number (☐ 168).
- Non-CPU lens is attached but camera is not in mode **M** (☐ 169).

Only one shot taken each time shutter-release button is pressed in continuous shooting mode: Continuous shooting is not available if built-in flash fires (☐ 32, 47).

Final photo is larger than area shown in viewfinder: Viewfinder horizontal and vertical frame coverage is approximately 95%.

Photos are out of focus:

- AF-S or AF-I lens is not attached: use AF-S or AF-I lens or focus manually.
- Camera unable to focus using autofocus: use manual focus or focus lock (☐ 40, 42).
- Camera is in manual focus mode: focus manually (☐ 42).



Focus does not lock when shutter-release button is pressed halfway: Use $\overline{\text{AF-L}}$ (O-n) button to lock focus when live view is off and **AF-C** is selected for focus mode or when photographing moving subjects in **AF-A** mode (☞ 40).

Can not select focus point:

- $\overline{\text{AF-ON}}$ **Auto-area AF** selected for **AF-area mode** > **Viewfinder** (☞ 38, 39): choose another mode.
 - Press shutter-release button halfway to turn monitor off or start standby timer (☞ 24).
-

Can not select AF-area mode: Manual focus selected (☞ 35, 82).

Image size can not be changed: **Image quality** set to **NEF (RAW)** or **NEF (RAW) + JPEG fine** (☞ 45).

Camera is slow to record photos: Turn noise reduction off (☞ 131).

Noise (bright spots, randomly-spaced bright pixels, fog, or lines) appear in photos:

- Choose lower ISO sensitivity or turn noise reduction on (☞ 131).
 - Shutter speed is slower than 1 s: use noise reduction (☞ 131).
 - Turn **Active D-Lighting** off to avoid heightening the effects of noise (☞ 67).
-

No photo taken when remote control shutter-release button is pressed:

- Replace battery in remote control (☞ 177).
 - Choose remote control release mode (☞ 33).
 - Flash is charging (☞ 24).
 - Time selected for **Remote on duration** (☞ 141) has elapsed.
 - Bright light is interfering with remote.
-

Beep does not sound:

- **Off** is selected for **Beep** (☞ 141).
 - Camera is in quiet shutter-release mode (☞ 31), or movie is being recorded (☞ 88).
 - **MF** or **AF-C** is selected as the focus mode or subject moves when **AF-A** is selected (☞ 35).
-

Smudges appear in photographs: Clean front and rear lens elements. If problem persists, perform image sensor cleaning (☞ 180).

Date is not imprinted on photos: **Image quality** set to **NEF (RAW)** or **NEF (RAW) + JPEG fine** (☞ 45, 144).

Sound is not recorded with movies: **Microphone off** is selected for **Movie settings** > **Microphone** (☞ 90).

Flicker or banding appears during live view or movie recording: Choose an option for **Flicker reduction** that matches the frequency of the local AC power supply (☞ 136).

Menu item can not be selected: Some options are not available in all modes.



Shooting (P, S, A, M)

Shutter-release disabled:

- Non-CPU lens is attached: rotate camera mode dial to **M** (☞ 169).
- Mode dial rotated to **S** after shutter speed of “Bulb” or “Time” selected in mode **M**: choose new shutter speed (☞ 55).

Full range of shutter speeds not available:

- Flash in use (☞ 50).
- When **On** is selected for **Movie settings > Manual movie settings** in the shooting menu, the range of available shutter speed varies with the frame rate (☞ 91).

Colors are unnatural:

- Adjust white balance to match light source (☞ 69).
- Adjust **Set Picture Control** settings (☞ 76).

Can not measure white balance: Subject is too dark or too bright (☞ 73).

Image can not be selected as source for preset white balance: Image was not created with D3200 (☞ 75).

Effects of Picture Control differ from image to image: **A** (auto) is selected for sharpening, contrast, or saturation. For consistent results over a series of photos, choose another setting (☞ 78).

Metering can not be changed: Autoexposure lock is in effect (☞ 61).

Exposure compensation can not be used: Choose mode **P, S, or A** (☞ 53, 63).

Noise (reddish areas or other artifacts) appears in long time-exposures: Turn noise reduction on (☞ 131).

Playback

NEF (RAW) image is not played back: Photo was taken at image quality of **NEF (RAW) + JPEG fine** (☞ 45).

Some pictures are not displayed during playback: Select **All** for **Playback folder**. Note that **Current** is automatically selected after photograph is taken (☞ 125).

“Tall” (portrait) orientation photos are displayed in “wide” (landscape) orientation:

- Select **On** for **Rotate tall** (☞ 126).
- Photo was taken with **Off** selected for **Auto image rotation** (☞ 138).
- Photo is displayed in image review (☞ 126).
- Camera was pointed up or down when photo was taken (☞ 138).

Can not delete picture:

- Picture is protected: remove protection (☞ 105).
- Memory card is locked (☞ 18).

Can not retouch picture: Photo can not be further edited with this camera (☞ 149).



Can not change print order:

- Memory card is full: delete pictures (☞ 21, 106).
- Memory card is locked (☞ 18).

Can not select photo for printing: Photo is in NEF (RAW) format. Create JPEG copy using **NEF (RAW) processing** or transfer to computer and print using supplied software or Capture NX 2 (☞ 111, 157).

Picture is not displayed on TV:

- Choose correct video mode (☞ 136) or output resolution (☞ 124).
- A/V (☞ 122) or HDMI (☞ 123) cable is not correctly connected.

Camera does not respond to remote control for HDMI-CEC television:

- Select **On** for **HDMI > Device control** in the setup menu (☞ 124).
- Adjust HDMI-CEC settings for the television as described in documentation provided with the device.

Can not transfer photos to computer: OS not compatible with camera or transfer software. Use card reader to copy photos to computer (☞ 111).

Photos are not displayed in Capture NX 2: Update to latest version (☞ 176).

Image Dust Off option in Capture NX 2 does not have desired effect: Image sensor cleaning changes the position of dust on the low-pass filter. Image Dust Off reference data recorded before image sensor cleaning is performed can not be used with photographs taken after image sensor cleaning is performed. Image Dust Off reference data recorded after image sensor cleaning is performed can not be used with photographs taken before image sensor cleaning is performed (☞ 139).

Miscellaneous



Date of recording is not correct: Set camera clock (☞ 16, 137).









Menu item can not be selected: Some options are not available at certain combinations of settings or when no memory card is inserted (☞ 18, 149, 187).

Error Messages









This section lists the indicators and error messages that appear in the viewfinder and monitor.

Warning Icons

A flashing  in the monitor or  in the viewfinder indicates that a warning or error message can be displayed in the monitor by pressing the  (?) button.

Indicator		Solution	
Monitor	Viewfinder		
Lock lens aperture ring at minimum aperture (largest f-number).	 (flashes)	Set lens aperture ring to minimum aperture (highest f-number).	15, 168
Lens not attached	 (flashes)	<ul style="list-style-type: none"> • Attach non-IX NIKKOR lens. • If non-CPU lens is attached, select mode M. 	167 57
Before taking photos, rotate the zoom ring to extend the lens.	 (flashes)	A lens with a retractable lens barrel button is attached with the lens barrel retracted. Press the retractable lens barrel button and rotate the zoom ring to extend the lens.	15
Shutter release disabled. Recharge battery.	 (flashes)	Turn camera off and recharge or replace battery.	12, 13
This battery cannot be used. Choose battery designated for use in this camera.	 (flashes)	Use Nikon-approved battery.	176
Initialization error. Turn camera off and then on again.	 (flashes)	Turn camera off, remove and replace battery, and then turn camera on again.	2, 13
Battery level is low. Complete operation and turn camera off immediately.	—	End cleaning and turn camera off and recharge or replace battery.	183
Clock not set	—	Set camera clock.	16, 137
No SD card inserted	 (flashes)	Turn camera off and confirm that card is correctly inserted.	18
Memory card is locked. Slide lock to “write” position.	 (flashes)	Memory card is locked (write protected). Slide card write-protect switch to “write” position.	18



Indicator		Solution	📖
Monitor	Viewfinder		
This memory card cannot be used. Card may be damaged. Insert another card.	 (flashes)	• Use approved card.	177
		• Format card. If problem persists, card may be damaged. Contact Nikon-authorized service representative.	19
		• Error creating new folder. Delete files or insert new memory card.	106
		• Insert new memory card.	18
		• Eye-Fi card is still emitting wireless signal after Disable has been selected for Eye-Fi upload . To terminate wireless transmission, turn the camera off and remove the card.	148
Not available if Eye-Fi card is locked.	 (flashes)	Eye-Fi card is locked (write protected). Slide card write-protect switch to “write” position.	18
This card is not formatted. Format card?	 (flashes)	Format card or turn camera off and insert new memory card.	19
Card is full	 (flashes)	• Reduce quality or size.	44
		• Delete photographs.	106
		• Insert new memory card.	18
—	 (flashes)	Camera can not focus using autofocus. Change composition or focus manually.	23, 36, 42
Subject is too bright	 (flashes)	• Use a lower ISO sensitivity.	51
		• Use commercial ND filter.	176
Subject is too dark	 (flashes)	• In mode: S Increase shutter speed	55
		A Choose a smaller aperture (higher f-number)	56
		• Use a higher ISO sensitivity.	51
		• Use flash.	47
No Bulb in S mode	 (flashes)	• In mode: S Lower shutter speed	55
		A Choose a larger aperture (lower f-number)	56
—	 (flashes)	Flash has fired at full power. Check photo in monitor; if underexposed, adjust settings and try again.	—



Indicator		Solution	📖
Monitor	Viewfinder		
—	⚡/? (flashes)	<ul style="list-style-type: none"> Use the flash. Change distance to subject, aperture, flash range, or ISO sensitivity. Lens focal length is less than 18 mm: use a longer focal length. Optional SB-400 flash unit attached: flash is in bounce position or focus distance is very short. Continue shooting; if necessary, increase focus distance to prevent shadows from appearing in photograph. 	47 50, 51, 56 — —
Flash error	? (flashes)	Error occurred updating firmware for optional flash unit. Contact Nikon-authorized service representative.	—
Error. Press shutter release button again.	Err (flashes)	Release shutter. If error persists or appears frequently, consult Nikon-authorized service representative.	—
Start-up error. Contact a Nikon-authorized service representative.		Consult Nikon-authorized service representative.	—
Metering error			
Unable to start live view. Please wait for camera to cool.	—	Wait for the internal circuits to cool before resuming live view or movie recording.	86, 89
Folder contains no images.	—	Folder selected for playback contains no images. Insert another memory card or select a different folder.	18, 125
Cannot display this file.	—	File can not be played back on camera.	—
Cannot select this file.	—	Images created with other devices can not be retouched.	150
No image for retouching.	—	Memory card does not contain NEF (RAW) images for use with NEF (RAW) processing .	157
Check printer.	—	Check printer. To resume, select Continue (if available).	—*
Check paper.	—	Paper is not selected size. Insert paper of correct size and select Continue .	—*
Paper jam.	—	Clear jam and select Continue .	—*
Out of paper.	—	Insert paper of selected size and select Continue .	—*
Check ink supply.	—	Check ink. To resume, select Continue .	—*
Out of ink.	—	Replace ink and select Continue .	—*

* See printer manual for more information.



Specifications

■ ■ Nikon D3200 Digital Camera

Type	
Type	Single-lens reflex digital camera
Lens mount	Nikon F mount (with AF contacts)
Effective angle of view	Approx. 1.5 × lens focal length (35 mm format equivalent); Nikon DX format
Effective pixels	
Effective pixels	24.2 million
Image sensor	
Image sensor	23.2 × 15.4 mm CMOS sensor
Total pixels	24.7 million
Dust-reduction System	Image sensor cleaning, Image Dust Off reference data (optional Capture NX 2 software required)
Storage	
Image size (pixels)	<ul style="list-style-type: none"> • 6,016 × 4,000 (Large) • 3,008 × 2,000 (Small) • 4,512 × 3,000 (Medium)
File format	<ul style="list-style-type: none"> • NEF (RAW): 12 bit, compressed • JPEG: JPEG-Baseline compliant with fine (approx. 1 : 4), normal (approx. 1 : 8), or basic (approx. 1 : 16) compression • NEF (RAW)+JPEG: Single photograph recorded in both NEF (RAW) and JPEG formats
Picture Control System	Standard, Neutral, Vivid, Monochrome, Portrait, Landscape; selected Picture Control can be modified
Media	SD (Secure Digital) and UHS-I compliant SDHC and SDXC memory cards
File system	DCF (Design Rule for Camera File System) 2.0, DPOF (Digital Print Order Format), Exif (Exchangeable Image File Format for Digital Still Cameras) 2.3, PictBridge
Viewfinder	
Viewfinder	Eye-level pentamirror single-lens reflex viewfinder
Frame coverage	Approx. 95% horizontal and 95% vertical
Magnification	Approx. 0.8 × (50 mm f/1.4 lens at infinity, -1.0 m ⁻¹)
Eyepoint	18 mm (-1.0 m ⁻¹ ; from center surface of viewfinder eyepiece lens)
Diopter adjustment	-1.7 – +0.5 m ⁻¹
Focusing screen	Type B BriteView Clear Matte Mark VII screen
Reflex mirror	Quick return
Lens aperture	Instant return, electronically controlled





Lens	
Compatible lenses	Autofocus is available with AF-S and AF-I lenses. Autofocus is not available with other type G and D lenses, AF lenses (IX NIKKOR and lenses for the F3AF are not supported), and AI-P lenses. Non-CPU lenses can be used in mode M , but the camera exposure meter will not function. The electronic rangefinder can be used with lenses that have a maximum aperture of f/5.6 or faster.
Shutter	
Type	Electronically-controlled vertical-travel focal-plane shutter
Speed	$1/4000$ – 30 s in steps of $1/3$ EV; Bulb; Time (requires optional ML-L3 remote control)
Flash sync speed	X= $1/200$ s; synchronizes with shutter at $1/200$ s or slower
Release	
Release mode	(single frame), (continuous), (self-timer), 2s (delayed remote), (quick-response remote), (quiet shutter release)
Frame advance rate	Up to 4 fps (manual focus, mode M or S , shutter speed $1/250$ s or faster, and other settings at default values)
Self-timer	2 s, 5 s, 10 s, 20 s; 1–9 exposures
Exposure	
Metering	TTL exposure metering using 420-pixel RGB sensor
Metering method	<ul style="list-style-type: none"> • Matrix metering: 3D color matrix metering II (type G and D lenses); color matrix metering II (other CPU lenses) • Center-weighted metering: Weight of 75% given to 8-mm circle in center of frame • Spot metering: Meters 3.5-mm circle (about 2.5% of frame) centered on selected focus point
Range (ISO 100, f/1.4 lens, 20 °C/68 °F)	<ul style="list-style-type: none"> • Matrix or center-weighted metering: 0–20 EV • Spot metering: 2–20 EV
Exposure meter coupling	CPU
Mode	Auto modes (auto; auto (flash off)); scene modes (portrait; landscape; child; sports; close up; night portrait); programmed auto with flexible program (P); shutter-priority auto (S); aperture-priority auto (A); manual (M)
Exposure compensation	–5 – +5 EV in increments of $1/3$ EV
Exposure lock	Luminosity locked at detected value with (O-m) button
ISO sensitivity (Recommended Exposure Index)	ISO 100 – 6400 in steps of 1 EV; can also be set to approx. 1 EV above ISO 6400 (ISO 12800 equivalent); auto ISO sensitivity control available
Active D-Lighting	On, off



Focus	
Autofocus	Nikon Multi-CAM 1000 autofocus sensor module with TTL phase detection, 11 focus points (including one cross-type sensor), and AF-assist illuminator (range approx. 0.5–3 m/1 ft 8 in.–9 ft 10 in.)
Detection range	–1 – +19 EV (ISO 100, 20 °C/68 °F)
Lens servo	<ul style="list-style-type: none"> • Autofocus (AF): Single-servo AF (AF-S); continuous-servo AF (AF-C); auto AF-S/AF-C selection (AF-A); predictive focus tracking activated automatically according to subject status • Manual focus (MF): Electronic rangefinder can be used
Focus point	Can be selected from 11 focus points
AF-area mode	Single-point AF, dynamic-area AF, auto-area AF, 3D-tracking (11 points)
Focus lock	Focus can be locked by pressing shutter-release button halfway (single-servo AF) or by pressing $\overset{\text{AE-L}}{\text{AF-L}}$ (○/⬅) button
Flash	
Built-in flash	 : Auto flash with auto pop-up P, S, A, M: Manual pop-up with button release
Guide Number	Approx. 12/39, 13/43 with manual flash (m/ft, ISO 100, 20 °C/68 °F)
Flash control	TTL: i-TTL flash control using 420-pixel RGB sensor is available with built-in flash and SB-910, SB-900, SB-800, SB-700, SB-600, or SB-400; i-TTL balanced fill-flash for digital SLR is used with matrix and center-weighted metering, standard i-TTL flash for digital SLR with spot metering
Flash mode	Auto, auto with red-eye reduction, auto slow sync, auto slow sync with red-eye reduction, fill-flash, red-eye reduction, slow sync, slow sync with red-eye reduction, rear-curtain with slow sync, rear-curtain sync, off
Flash compensation	–3 – +1 EV in increments of $\frac{1}{3}$ EV
Flash-ready indicator	Lights when built-in flash or optional flash unit is fully charged; flashes after flash is fired at full output
Accessory shoe	ISO 518 hot-shoe with sync and data contacts and safety lock
Nikon Creative Lighting System (CLS)	Advanced Wireless Lighting supported with SB-910, SB-900, SB-800, or SB-700 as a master flash, or SU-800 as commander; Flash Color Information Communication supported with all CLS-compatible flash units
Sync terminal	AS-15 sync terminal adapter (available separately)
White balance	
White balance	Auto, incandescent, fluorescent (7 types), direct sunlight, flash, cloudy, shade, preset manual, all except preset manual with fine-tuning.



Live view	
Lens servo	<ul style="list-style-type: none"> • Autofocus (AF): Single-servo AF (AF-S); full-time servo AF (AF-F) • Manual focus (MF)
AF-area mode	Face-priority AF, wide-area AF, normal-area AF, subject-tracking AF
Autofocus	Contrast-detect AF anywhere in frame (camera selects focus point automatically when face-priority AF or subject-tracking AF is selected)
Automatic scene selection	Available in  and  modes
Movie	
Metering	TTL exposure metering using main image sensor
Metering method	Matrix
Frame size (pixels) and frame rate	<ul style="list-style-type: none"> • 1,920 × 1,080, 30 p (progressive)/25p/24p, ★ high/normal • 1,280 × 720, 60p/50p, ★ high/normal • 640 × 424, 30p/25p, ★ high/normal <p>Frame rates of 30p (actual frame rate 29.97 fps) and 60p (actual frame rate 59.94 fps) are available when NTSC is selected for video mode. 25p and 50p are available when PAL is selected for video mode. Actual frame rate when 24p is selected is 23.976 fps.</p>
File format	MOV
Video compression	H.264/MPEG-4 Advanced Video Coding
Audio recording format	Linear PCM
Audio recording device	Built-in monaural or external stereo microphone; sensitivity adjustable
ISO sensitivity	ISO 200–6400; can also be set to approx. 1 EV above ISO 6400 (ISO 12800 equivalent)
Monitor	
Monitor	7.5-cm (3-in.), approx. 921k-dot (VGA) TFT LCD with 160° viewing angle, approx. 100% frame coverage, and brightness adjustment
Playback	
Playback	Full-frame and thumbnail (4, 9, or 72 images or calendar) playback with playback zoom, movie playback, photo and/or movie slide shows, histogram display, highlights, auto image rotation, and image comment (up to 36 characters)
Interface	
USB	Hi-Speed USB
Video output	NTSC, PAL
HDMI output	Type C mini-pin HDMI connector
Accessory terminal	Remote cord: MC-DC2 (available separately) GPS unit: GP-1 (available separately)
Audio input	Stereo mini-pin jack (3.5mm diameter)



Supported languages	
Supported languages	Arabic, Chinese (Simplified and Traditional), Czech, Danish, Dutch, English, Finnish, French, German, Greek, Hindi, Hungarian, Indonesian, Italian, Japanese, Korean, Norwegian, Polish, Portuguese (Portugal and Brazil), Romanian, Russian, Spanish, Swedish, Thai, Turkish, Ukrainian
Power source	
Battery	One rechargeable Li-ion EN-EL14 battery
AC adapter	EH-5b AC adapter; requires EP-5A power connector (available separately)
Tripod socket	
Tripod socket	1/4 in. (ISO 1222)
Dimensions/weight	
Dimensions (W × H × D)	Approx. 125 × 96 × 76.5 mm (5.0 × 3.8 × 3.1 in.)
Weight	Approx. 505 g (1 lb 1.8 oz) with battery and memory card but without body cap; approx. 455 g/1 lb (camera body only)
Operating environment	
Temperature	0–40 °C (+32–104 °F)
Humidity	Less than 85% (no condensation)

- Unless otherwise stated, all figures are for a camera with a fully-charged battery operating at an ambient temperature of 20 °C (68 °F).
- Nikon reserves the right to change the specifications of the hardware and software described in this manual at any time and without prior notice. Nikon will not be held liable for damages that may result from any mistakes that this manual may contain.



■ ■ *MH-24 battery charger*

Rated input	AC 100–240 V, 50/60 Hz, 0.2 A maximum
Rated output	DC 8.4 V/0.9 A
Supported batteries	Nikon rechargeable Li-ion battery EN-EL14
Charging time	Approx. 1 hour and 30 minutes at an ambient temperature of 25 °C/77 °F when no charge remains
Operating temperature	0–40 °C (+32–104 °F)
Dimensions (W × H × D)	Approx. 70 × 26 × 97 mm (2.8 × 1.0 × 3.8 in.), excluding plug adapter
Weight	Approx. 96 g (3.4 oz), excluding plug adapter

■ ■ *EN-EL14 rechargeable Li-ion battery*

Type	Rechargeable lithium-ion battery
Rated capacity	7.4 V/1030 mAh
Operating temperature	0–40 °C (+32–104 °F)
Dimensions (W × H × D)	Approx. 38 × 53 × 14 mm (1.5 × 2.1 × 0.6 in.)
Weight	Approx. 48 g (1.7 oz), excluding terminal cover

■ ■ *AF-S DX NIKKOR 18–55mm f/3.5–5.6G VR II lens*

Type	Type G AF-S DX lens with built-in CPU and F mount
Focal length	18–55 mm
Maximum aperture	f/3.5–5.6
Lens construction	11 elements in 8 groups (including 1 aspherical lens element)
Angle of view	76°–28° 50′
Focal length scale	Graduated in millimeters (18, 24, 35, 45, 55)
Distance information	Output to camera
Zoom	Manual zoom using independent zoom ring
Focusing	Autofocus controlled by Silent Wave Motor and separate focus ring for manual focus
Vibration reduction	Lens shift using voice coil motors (VCMs)
Minimum focus distance	<ul style="list-style-type: none">• AF: 0.28 m (0.92 ft) from focal plane at all zoom positions• MF: 0.25 m (0.82 ft) from focal plane at all zoom positions
Diaphragm blades	7 (rounded diaphragm opening)
Diaphragm	Fully automatic
Aperture range	<ul style="list-style-type: none">• 18 mm focal length: f/3.5–22• 55 mm focal length: f/5.6–36 The minimum aperture displayed may vary depending on the size of the exposure increment selected with the camera.
Metering	Full aperture
Filter-attachment size	52 mm (P=0.75 mm)
Dimensions	Approx. 66 mm diameter × 59.5 mm (distance from camera lens-mount flange when lens is retracted)
Weight	Approx. 195 g (6.9 oz)



■ ■ AF-S DX NIKKOR 18–55mm f/3.5–5.6G VR lens

Type	Type G AF-S DX NIKKOR zoom lens with built-in CPU and F mount for use exclusively with Nikon DX-format digital SLR cameras
Focal length	18–55 mm
Maximum aperture	f/3.5–5.6
Lens construction	11 elements in 8 groups (including 1 aspherical element)
Angle of view	76 °–28 ° 50 ´
Focal length scale	Graduated in millimeters (18, 24, 35, 45, 55)
Distance information	Output to camera
Zoom	Manual zoom using independent zoom ring
Focusing	Autofocus controlled by Silent Wave Motor; manual focus
Vibration reduction	Lens-shift method using voice coil motors (VCMs)
Minimum focus distance	0.28 m from focal plane (□ 43) at all zoom positions
Diaphragm blades	7 (rounded diaphragm opening)
Diaphragm	Fully automatic
Aperture range	• 18 mm focal length: f/3.5–22 • 55 mm focal length: f/5.6–36
Metering	Full aperture
Filter-attachment size	52 mm (P=0.75 mm)
Dimensions	Approx. 73 mm diameter × 79.5 mm/2.9 × 3.1 in. (distance from camera lens-mount flange)
Weight	Approx. 265 g (9.3 oz)

Nikon reserves the right to change the specifications of the hardware and software described in this manual at any time and without prior notice. Nikon will not be held liable for damages that may result from any mistakes that this manual may contain.



Lenses

This section describes the features available with AF-S DX NIKKOR 18–55mm f/3.5–5.6G VR II and AF-S DX NIKKOR 18–55mm f/3.5–5.6G VR lenses.

■ The AF-S DX NIKKOR 18–55mm f/3.5–5.6G VR II

The AF-S DX NIKKOR 18–55mm f/3.5–5.6G VR II is for use exclusively with Nikon DX format digital cameras and features a retractable lens barrel (□ 14).

■ The AF-S DX NIKKOR 18–55mm f/3.5–5.6G VR

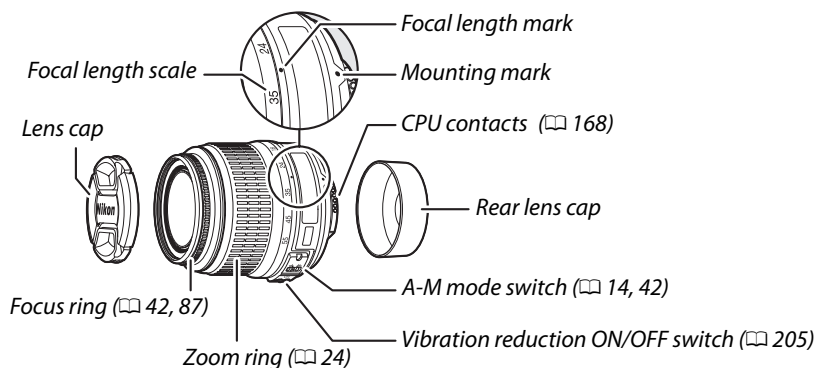

The AF-S DX NIKKOR 18–55mm f/3.5–5.6G VR is for use exclusively with Nikon DX format digital cameras.

📌 Using the Built-in Flash

When using the built-in flash, be sure the subject is at a range of at least 0.6 m (2 ft) and remove lens hoods to prevent vignetting (shadows created where the end of the lens obscures the built-in flash).

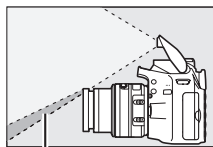

Shadow



Shadow

Camera	Minimum distance without vignetting
D7100/D7000/D5300/D5200/D5100/D5000/ D3200/D3100/D3000/D300 series/D200/ D100/D90/D80/D70 series/D60/D50/ D40 series	No vignetting at any focus distance

Because the built-in flash units for the D100 and D70 can only cover the angle of view of a lens with a focal of 20 mm or more; vignetting will occur at a focal length of 18 mm.

 **Lens Care**

- Keep the CPU contacts clean.
- Use a blower to remove dust and lint from the lens surfaces. To remove smudges and fingerprints, apply a small amount of ethanol or lens cleaner to a soft, clean cotton cloth or lens-cleaning tissue and clean from the center outwards using a circular motion, taking care not to leave smears or touch the glass with your fingers.
- Never use organic solvents such as paint thinner or benzene to clean the lens.
- The lens hood or NC filters can be used to protect the front lens element.
- Attach the front and rear caps before placing the lens in its flexible pouch.
- When a lens hood is attached, do not pick up or hold the lens or camera using only the hood.
- If the lens will not be used for an extended period, store it in a cool, dry location to prevent mold and rust. Do not store in direct sunlight or with naphtha or camphor moth balls.
- Keep the lens dry. Rusting of the internal mechanism can cause irreparable damage.
- Leaving the lens in extremely hot locations could damage or warp parts made from reinforced plastic.



■ ■ **Vibration Reduction (VR)**

AF-S DX NIKKOR 18–55mm f/3.5–5.6G VR II and AF-S DX NIKKOR 18–55mm f/3.5–5.6G VR lenses support vibration reduction (VR), which reduces blur caused by camera shake, allowing shutter speeds up to 4.0 stops slower than would otherwise be the case (measured at a focal length of 55 mm with a DX-format camera according to Camera and Imaging Products Association [CIPA] standards; effects vary with the photographer and shooting conditions). This increases the range of shutter speeds available and permits hand-held, tripod-free photography in a wide range of situations.

To use vibration reduction, slide the vibration reduction switch to **ON**. Vibration reduction is activated when the shutter-release button is pressed halfway, reducing the effects of camera shake on the image in the viewfinder and simplifying the process of framing the subject and focusing in both autofocus and manual focus modes. When the camera is panned, vibration reduction applies only to motion that is not part of the pan (if the camera is panned horizontally, for example, vibration reduction will be applied only to vertical shake), making it much easier to pan the camera smoothly in a wide arc.

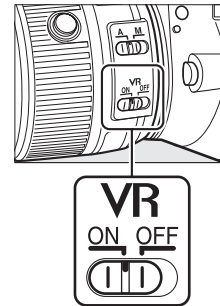

Turn vibration reduction off when the camera is securely mounted on a tripod, but leave it on if the tripod head is not secured or when using a monopod.

Vibration Reduction

Do not turn the camera off or remove the lens while vibration reduction is in effect. Vibration reduction is disabled while the built-in flash is charging. When vibration reduction is active, the image in the viewfinder may jiggle after the shutter is released. This does not indicate a malfunction; wait for the image in the viewfinder to stabilize before shooting.



Supplied Accessories for AF-S DX NIKKOR 18–55mm f/3.5–5.6G VR II and AF-S DX NIKKOR 18–55mm f/3.5–5.6G VR

- 52 mm Snap-on Front Lens Cap LC-52
- Rear Lens Cap

Optional Accessories for AF-S DX NIKKOR 18–55mm f/3.5–5.6G VR II

- 52 mm screw-on filters
- LF-1 and LF-4 rear lens caps
- Flexible Lens Pouch CL-0815
- Bayonet Hood HB-69

Align the lens hood mounting mark (●) with the lens hood alignment mark (↵) as shown in Figure ① and then rotate the hood (②) until the ● mark is aligned with the lens hood lock mark (—○).

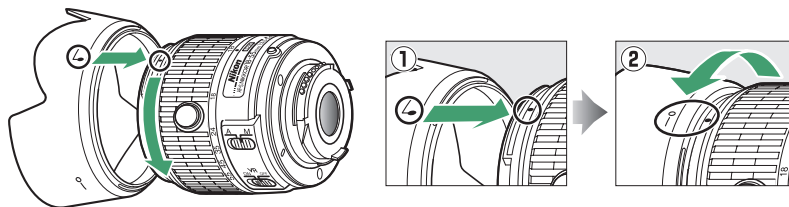

When attaching or removing the hood, hold it near the symbol on its base and avoid gripping it too tightly. Vignetting may occur if the hood is not correctly attached.

The hood can be reversed and mounted on the lens when not in use.

Optional Accessories for AF-S DX NIKKOR 18–55mm f/3.5–5.6G VR

- 52 mm screw-on filters
- LF-1 and LF-4 rear lens caps
- Flexible Lens Pouch CL-0815
- Lens Hood HB-45 (attaches as shown at right)

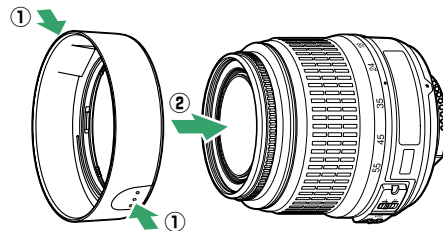

 **A Note on Wide- and Super Wide-Angle Lenses**

Autofocus may not provide the desired results in situations like those shown below.

1 Objects in the background occupy more of the focus point than the main subject:

If the focus point contains both foreground and background objects, the camera may focus on the background and the subject may be out of focus.



Example: *A far-off portrait subject at some distance from the background*

2 The subject contains many fine details.

The camera may have difficulty focusing on subjects that lack contrast or appear smaller than objects in the background.

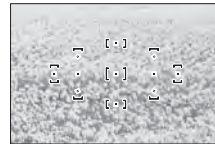

Example: *A field of flowers*

In these cases, use manual focus, or use focus lock to focus on another subject at the same distance and then recompose the photograph. For more information, see "Getting Good Results with Autofocus" (□ 36).



■ ■ **Supported Standards**

- **DCF Version 2.0:** The Design Rule for Camera File Systems (DCF) is a standard widely used in the digital camera industry to ensure compatibility among different makes of camera.
- **DPOF: Digital Print Order Format (DPOF)** is an industry-wide standard that allows pictures to be printed from print orders stored on the memory card.
- **Exif version 2.3:** The D3200 supports Exif (**Exchangeable Image File Format for Digital Still Cameras**) version 2.3, a standard in which information stored with photographs is used for optimal color reproduction when the images are output on Exif-compliant printers.
- **PictBridge:** A standard developed through cooperation with the digital camera and printer industries, allowing photographs to be output directly to a printer without first transferring them to a computer.
- **HDMI: High-Definition Multimedia Interface** is a standard for multimedia interfaces used in consumer electronics and AV devices capable of transmitting audiovisual data and control signals to HDMI-compliant devices via a single cable connection.

Trademark Information

Macintosh, Mac OS, and QuickTime are registered trademarks of Apple Inc. in the United States and/or other countries. Microsoft, Windows, and Windows Vista are either registered trademarks, or trademarks of Microsoft Corporation in the United States and/or other countries. PictBridge logo is a trademark. The SD, SDHC, and SDXC logos are trademarks of the SD-3C, LLC. HDMI, the **HDMI** logo and High-Definition Multimedia Interface are trademarks or registered trademarks of HDMI Licensing LLC. All other trade names mentioned in this manual or the other documentation provided with your Nikon product are trademarks or registered trademarks of their respective holders.



Battery Life

The number of shots that can be taken with fully-charged batteries varies with the condition of the battery, temperature, and how the camera is used. Sample figures for EN-EL14 (1030 mAh) batteries are given below.

- **Single-frame release mode (CIPA standard ¹):** Approximately 540 shots
- **Continuous release mode (Nikon standard ²):** Approximately 1800 shots
 - 1 Measured at 23 °C/73.4 °F (±2 °C/3.6 °F) with an AF-S DX NIKKOR 18–55mm f/3.5–5.6G VR II lens under the following test conditions: lens cycled from infinity to minimum range and one photograph taken at default settings once every 30 s; after photograph is taken, monitor is turned on for 4 s; tester waits for standby timer to expire after monitor is turned off; flash fired at full power once every other shot. Live view not used.
 - 2 Measured at 20 °C/68 °F with an AF-S DX NIKKOR 18–55mm f/3.5–5.6G VR II lens under the following test conditions: vibration reduction off, continuous release mode, focus mode set to **AF-C**, image quality set to JPEG basic, image size set to **M** (medium), white balance set to **AUTO**, ISO sensitivity set to ISO 100, shutter speed $1/250$ s, focus cycled from infinity to minimum range three times after shutter-release button has been pressed halfway for 3 s; six shots are then taken in succession and monitor turned on for 4 s and then turned off; cycle repeated once standby timer has expired.

The following can reduce battery life:

- Using the monitor
- Keeping the shutter-release button pressed halfway
- Repeated autofocus operations
- Taking NEF (RAW) photographs
- Slow shutter speeds
- Using a GP-1 GPS unit
- Using a WU-1a wireless mobile adapter
- Using VR (vibration reduction) mode with VR lenses

To ensure that you get the most from rechargeable Nikon EN-EL14 batteries:

- Keep the battery contacts clean. Soiled contacts can reduce battery performance.
- Use batteries immediately after charging. Batteries will lose their charge if left unused.



Index

Symbols

	(Auto mode).....	22
	(Auto (flash off) mode).....	22
	(Portrait).....	25
	(Landscape).....	25
	(Child).....	25
	(Sports).....	26
	(Close up).....	26
	(Night portrait).....	26
P	(Programmed auto).....	54
S	(Shutter-priority auto).....	55
A	(Aperture-priority auto).....	56
M	(Manual).....	57
GUIDE	(Guide).....	27
	(flexible program).....	54
	(Single frame).....	31
	(Continuous).....	31
	(Self-timer).....	31, 33, 141
	(Delayed remote).....	31, 33
	(Quick-response remote).....	31, 33
	(Quiet shutter release).....	31
	(Single-point AF).....	38
	(Dynamic-area AF).....	38
	(Auto-area AF).....	38
	(3D-tracking (11 points)).....	38, 39
	(Face-priority AF).....	82, 83
	(Wide-area AF).....	82, 83
	(Normal-area AF).....	82, 83
	(Subject-tracking AF).....	82, 83
	(Matrix metering).....	60
	(Center-weighted metering).....	60
	(Spot metering).....	60
AUTO	(auto flash).....	48, 49
	(red-eye reduction).....	48, 49
SLOW	(slow sync).....	48, 49
REAR	(rear-curtain sync).....	48, 49
	(Flash compensation).....	65
	(Exposure compensation).....	63
	(Help).....	9
WB	(White balance).....	69
PRE	(Preset manual).....	72
	(focus indicator).....	23, 40, 42, 61
	(flash-ready indicator).....	4, 24, 175
	(“Beep” indicator).....	141
	(live view).....	80, 88
	(Memory buffer).....	23, 32, 188

Numerics

3D color matrix metering II.....	60
3D-tracking.....	38, 39
3D-tracking (11 points) (AF-area mode).....	38, 39
420-pixel RGB sensor.....	60

A

A/V cable.....	122
AC adapter.....	176, 178
Access lamp.....	23
Accessories.....	176
Active D-Lighting.....	67, 143
Adobe RGB.....	130
AE lock.....	61, 144
AE-L.....	61, 143
AE-L/AF-L.....	143
AE-L/AF-L button.....	41, 61, 143
AF.....	35–41, 81–83
AF-A.....	35
AF-area mode.....	38, 82
AF-assist illuminator... ..	37, 131, 171
AF-C.....	35
AF-F.....	81
AF-S.....	35, 81
A-M mode switch.....	14, 42, 203
Angle of view.....	171
Aperture.....	53, 56
Aperture-priority auto.....	56
Assign AE-L/AF-L button.....	143
Assign Fn button.....	8, 143
Attaching the lens.....	14
Auto (White balance).....	69
Auto distortion control.....	130
Auto flash.....	49
Auto image rotation.....	138
Auto info display.....	136
Auto ISO sensitivity control.....	129
Auto off timers.....	140
Auto-area AF (AF-area mode)....	38
Autoexposure lock.....	61
Autofocus.....	35–41, 81–83
Auto-servo AF.....	35
Available settings.....	187

B

Battery.....	12, 13
Beep.....	141
Bit rate.....	90
Black-and-white.....	152
Blue intensifier (Filter effects) ..	153
Body cap.....	1, 14, 177
Border (PictBridge).....	116
Built-in AF-assist illuminator	37, 131, 171
Built-in flash.....	47, 132, 170
Bulb.....	58
Buttons.....	143

C

Calendar.....	103
Calendar playback.....	103
CEC.....	124
Center-weighted metering.....	60
Charging a battery.....	12
Choose start/end point.....	93
Clean image sensor.....	180
Clock.....	16, 137
Clock battery.....	17
Cloudy (White balance).....	69
CLS.....	173
Color balance.....	154
Color outline.....	160
Color sketch.....	160
Color space.....	130
Color temperature.....	70
Command dial.....	7
Compatible lens.....	167
Computer.....	111
Connecting a GPS to the camera... ..	147, 177
Continuous (Release mode).....	31
Continuous-servo AF.....	35
CPU contacts.....	168
CPU lens.....	15, 167
Creative Lighting System.....	173
Cross screen (Filter effects).....	153
Cyanotype.....	152

D

Date and time.....	16, 137
Date counter.....	144, 145
Date format.....	16, 137
Daylight saving time.....	16, 137
DCF version 2.0.....	130, 208
Delayed remote.....	31
Delete.....	106
Delete all images.....	107
Delete current image.....	106
Delete selected images.....	107
Device control (HDMI).....	124
Digital Print Order Format.....	117, 120, 208
Diopeter adjustment control.....	20, 176
Direct sunlight (White balance).....	69
Distortion control.....	159
D-Lighting.....	151
DPOF.....	117, 120, 208
DPOF print order.....	120
Dynamic-area AF.....	38

E	
Edit movie.....	93, 96
Electronic rangefinder.....	42
Exif version 2.3.....	130, 208
Exposure.....	53, 60, 61, 63
Exposure compensation.....	63
Exposure indicator.....	57, 84
Exposure lock.....	61
Exposure meters.....	24, 140
Exposure mode.....	53
External microphone.....	91, 177
Eye-Fi upload.....	148
F	
Face-priority AF.....	82
File information.....	98
File number sequence.....	142
Filter effects.....	78, 79, 153
Fine-tuning white balance.....	71
Firmware version.....	148
Fisheye.....	160
Flash.....	24, 47, 48, 172
Flash (White balance).....	69
Flash compensation.....	65
Flash control.....	132
Flash mode.....	48
Flash range.....	50
Flash ready indicator.....	24, 175
Flash sync speed.....	50, 197
Flexible program.....	54
Flicker reduction.....	89, 136
Fluorescent (White balance).....	69, 70
Fn button.....	8, 143
f-number.....	53, 56, 167
Focal length.....	171
Focal length scale.....	14, 203
Focal plane mark.....	43
Focus.....	35–43, 81–83, 87
Focus indicator.....	23, 40, 42, 61
Focus lock.....	40
Focus mode.....	35, 81
Focus point.....	22, 38, 40, 42, 82, 83
Focusing screen.....	196
Focusing the viewfinder.....	20
Focus-mode switch.....	14, 42
Format memory card.....	19
Frame interval (Slide show).....	109
Frame size/frame rate.....	90
Framing grid.....	85
Front-curtain sync.....	49
Full-frame playback.....	97
Full-time-servo AF.....	81
G	
GP-1.....	147, 177
GPS.....	101, 147, 177
GPS data.....	101
Green intensifier (Filter effects).....	153
Guide mode.....	27
H	
H.264.....	199
HDMI.....	123, 208
HDMI-CEC.....	124
Help.....	9
Hi (Sensitivity).....	51
High definition.....	123, 208
Highlights.....	98, 126
Histogram.....	99, 126
I	
Image comment.....	138
Image Dust Off ref photo.....	139
Image overlay.....	155
Image quality.....	44
Image review.....	126
Image size.....	46
Incandescent (White balance) ..	69
Info display format.....	134
In-focus indicator.....	23, 40, 42, 61
Information.....	5, 98, 134
Infrared receiver.....	33
ISO sensitivity.....	51, 129
i-TTL.....	132
i-TTL balanced fill-flash for digital SLR.....	132
J	
JPEG.....	44
JPEG basic.....	44
JPEG fine.....	44
JPEG normal.....	44
L	
Landscape (Set Picture Control).....	76
Language.....	16, 137
Large (Image size).....	46
Lens.....	14, 15, 167, 203
Lens cap.....	14
Lens focus ring.....	14, 203
Lens mount.....	1, 14, 43
Lens vibration reduction switch ..	14, 203, 205
Live view.....	80, 88
Lock mirror up for cleaning.....	182
M	
Manual.....	42, 57
Manual focus.....	42, 81, 87
Manual movie settings.....	91
Matrix metering.....	60
Maximum aperture.....	42, 167
Maximum sensitivity.....	129
Medium (Image size).....	46
Memory buffer.....	23, 32
Memory card.....	18, 177, 188
Memory card capacity.....	188
Metering.....	60
Microphone.....	88, 90
Miniature effect.....	162
Minimum aperture.....	15, 53
Minimum shutter speed.....	129
Mirror.....	1, 182
Mode dial.....	3
Monitor.....	80, 97, 134
Monitor brightness.....	134
Monochrome.....	152
Monochrome (Set Picture Control).....	76
Mounting mark.....	14, 203
MOV.....	188
Movie quality.....	90
Movie settings.....	90
Movie-record button.....	88
Movies.....	88
N	
NEF.....	44
NEF (RAW).....	44, 157
NEF (RAW) processing.....	157
Neutral (Set Picture Control).....	76
Nikon Transfer 2.....	111, 112
Noise reduction.....	131
Non-CPU lens.....	169
Normal-area AF.....	82
Number of shots.....	209
O	
Optional flash.....	132, 172
Output resolution (HDMI).....	124
Overview data.....	101
P	
Page size (PictBridge).....	116
Perspective control.....	161
Photo information.....	98, 126
PictBridge.....	114, 208
Picture Controls.....	76, 77
Playback.....	97
Playback display options.....	126
Playback folder.....	125
Playback information.....	98, 126
Playback menu.....	125
Playback zoom.....	104
Portrait (Set Picture Control).....	76
Power switch.....	1



Preset manual (White balance) 69, 72
 Press the shutter-release button all the way down 23, 24
 Press the shutter-release button halfway 23, 24
 Print (DPOF) 117
 Print date 144
 Print select 117
 Printing 114
 Programmed auto 54
 Protecting photographs 105

Q

Quick retouch 159
 Quick-response remote 31
 Quiet shutter release 31

R

Rangefinder 142
 Rear lens cap 14
 Rear-curtain sync 49
 Recent settings 166
 Red intensifier (Filter effects) ... 153
 Red-eye correction 151
 Red-eye reduction 49
 Release mode 31
 Remote control 33, 141, 177
 Remote cord 58, 177
 Remote on duration 141
 Removing the lens from the camera 15
 Reset setup options 134
 Reset shooting options 128
 Resize 158
 Retouch menu 149
 Retractable lens barrel button .. 15
 RGB 99, 130
 RGB Histogram 99
 Rotate tall 126

S

Save selected frame 96
 Scene auto selector 85
 Scene mode 25
 Selective color 163
 Self-timer 31, 33, 141
 Sensitivity 51, 129
 Sepia 152
 Set Picture Control 77
 Setup menu 133
 Shade (White balance) 69
 Shooting data 100
 Shooting menu 127
 Shutter-priority auto 55

Shutter-release button.. 23, 24, 40, 61
 Shutter-release button AE-L 144
 Side-by-side comparison 165
 Single frame (Release mode) 31
 Single-point AF (AF-area mode) 38
 Single-servo AF 35, 81
 Size 46, 90
 Skylight (Filter effects) 153
 Slide show 109
 Slot empty release lock 144
 Slow sync 49
 Small (Image size) 46
 Soft (Filter effects) 153
 Speedlight 172
 Spot metering 60
 sRGB 130
 Standard (Set Picture Control) ... 76
 Standard i-TTL fill-flash for digital SLR 132
 Standby timer 24, 140, 147
 Start printing (PictBridge) 116, 119
 Storage folder 146
 Straighten 159
 Subject-tracking AF 82

T

Television 122
 Thumbnail playback 102
 Time 58
 Time stamp (PictBridge) 116
 Time zone 16, 137
 Time zone and date 16, 137
 Timer 33
 Toning 78, 79
 Transition effects (Playback display options) 126
 Transition effects (Slide show) .109
 Trim 152
 Trimming movies 93
 Type D lens 168
 Type G lens 168

U

USB 112, 114
 USB cable 112, 114
 UTC 16, 101, 147

V

Vibration Reduction 205
 Video mode 122, 136
 Viewfinder 4, 20, 196
 Viewfinder eyepiece cap 34
 ViewNX 2 111
 Vivid (Set Picture Control) 76
 Volume 92

W

Warm filter (Filter effects) 153
 WB 69
 White balance 69
 Wide-area AF 82
 Wireless mobile adapter 177





No reproduction in any form of this manual, in whole or in part (except for brief quotation in critical articles or reviews), may be made without written authorization from NIKON CORPORATION.

NIKON CORPORATION

© 2012 Nikon Corporation



SB5F02(11)
6MB22611-02